

CPD-E500/E500E

SERVICE MANUAL

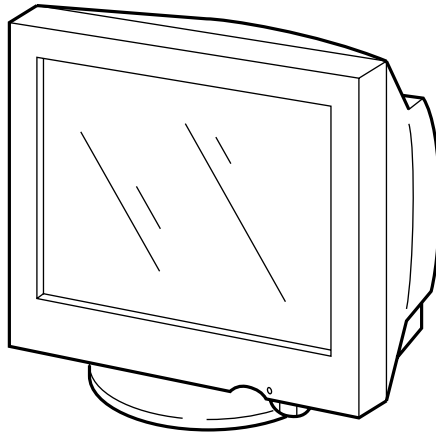

CPD-E500
US Model
Canadian Model
Chassis No. SCC-L22P-A

CPD-E500E
AEP Model
Chassis No. SCC-L22N-A

G1 CHASSIS

SPECIFICATIONS

CRT	0.24 mm aperture grille pitch 21 inches measured diagonally 90-degree deflection FD Trinitron	AC input voltage/current Power consumption Dimensions	100 to 240 V, 50 – 60 Hz, 2.0 – 1.0 A Approx. 145 W Approx. 497 × 480 × 478 mm (w/h/d) (19 ⁵ / ₈ × 19 × 18 ⁷ / ₈ inches)
Viewable image size	Approx. 403.8 × 302.2 mm (w/h) (16 × 12 inches) 19.8" viewing image	Mass Plug and Play Supplied accessories	Approx. 32 kg (70 lb 9 oz) DDC1/2B/2Bi, GTF** See page 6
Resolution		* Recommended horizontal and vertical timing condition	
Maximum	Horizontal: 2048 dots Vertical: 1536 lines	• Horizontal sync width duty should be more than 4.8% of total horizontal time or 0.8 μs, whichever is larger.	
Recommended	Horizontal: 1600 dots Vertical: 1200 lines	• Horizontal blanking width should be more than 2.3 μsec.	
Standard image area	Approx. 388 × 291 mm (w/h) (15 ³ / ₈ × 11 ¹ / ₂ inches) or Approx. 364 × 291 mm (w/h) (14 ³ / ₈ × 11 ¹ / ₂ inches)	• Vertical blanking width should be more than 450 μsec.	** If the input signal is Generalized Timing Formula (GTF) compliant, the GTF feature of the monitor will automatically provide an optimal image for the screen.
Deflection frequency*	Horizontal: 30 to 109 kHz Vertical: 48 to 160 Hz	Design and specifications are subject to change without notice.	

TRINITRON® COLOR COMPUTER DISPLAY

SONY®

SAFETY CHECK-OUT

After correcting the original service problem, perform the following safety checks before releasing the set to the customer:

1. Check the area of your repair for unsoldered or poorly-soldered connections. Check the entire board surface for solder splashes and bridges.
2. Check the interboard wiring to ensure that no wires are “pinched” or contact high-wattage resistors.
3. Check that all control knobs, shields, covers, ground straps, and mounting hardware have been replaced. Be absolutely certain that you have replaced all the insulators.
4. Look for unauthorized replacement parts, particularly transistors, that were installed during a previous repair. Point them out to the customer and recommend their replacement.
5. Look for parts which, though functioning, show obvious signs of deterioration. Point them out to the customer and recommend their replacement.
6. Check the line cords for cracks and abrasion. Recommend the replacement of any such line cord to the customer.
7. Check the B+ and HV to see if they are specified values. Make sure your instruments are accurate; be suspicious of your HV meter if sets always have low HV.
8. Check the antenna terminals, metal trim, “metallized” knobs, screws, and all other exposed metal parts for AC Leakage. Check leakage as described below.

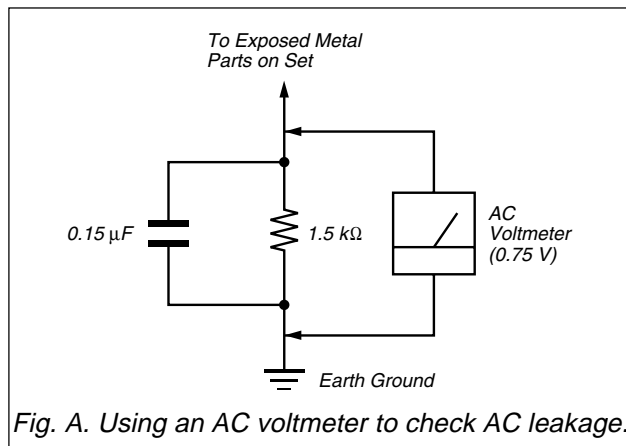

LEAKAGE TEST

The AC leakage from any exposed metal part to earth ground and from all exposed metal parts to any exposed metal part having a return to chassis, must not exceed 0.5 mA (500 microamperes).

Leakage current can be measured by any one of three methods.

1. A commercial leakage tester, such as the Simpson 229 or RCA WT-540A. Follow the manufacturers' instructions to use these instruments.
2. A battery-operated AC milliammeter. The Data Precision 245 digital multimeter is suitable for this job.
3. Measuring the voltage drop across a resistor by means of a VOM or battery-operated AC voltmeter. The “limit” indication is 0.75 V, so analog meters must have an accurate low-voltage scale. The Simpson 250 and Sanwa SH-63Trd are examples of a passive VOMs that are suitable. Nearly all battery operated digital multimeters that have a 2 V AC range are suitable. (See Fig. A)

WARNING!!

NEVER TURN ON THE POWER IN A CONDITION IN WHICH THE DEGAUSS COIL HAS BEEN REMOVED.

SAFETY-RELATED COMPONENT WARNING!!

COMPONENTS IDENTIFIED BY SHADING AND MARK \triangle ON THE SCHEMATIC DIAGRAMS, EXPLODED VIEWS AND IN THE PARTS LIST ARE CRITICAL FOR SAFE OPERATION. REPLACE THESE COMPONENTS WITH SONY PARTS WHOSE PART NUMBERS APPEAR AS SHOWN IN THIS MANUAL OR IN SUPPLEMENTS PUBLISHED BY SONY. CIRCUIT ADJUSTMENTS THAT ARE CRITICAL FOR SAFE OPERATION ARE IDENTIFIED IN THIS MANUAL. FOLLOW THESE PROCEDURES WHENEVER CRITICAL COMPONENTS ARE REPLACED OR IMPROPER OPERATION IS SUSPECTED.

AVERTISSEMENT!!

NE JAMAIS METTRE SOUS TENSION QUAND LA BOBINE DE DEMAGNETISATION EST ENLEVÉE.

ATTENTION AUX COMPOSANTS RELATIFS À LA SÉCURITÉ!!

LES COMPOSANTS IDENTIFIÉS PAR UNE TRAME ET UNE MARQUE \triangle SONT CRITIQUES POUR LA SÉCURITÉ. NE LES REMPLACER QUE PAR UNE PIÈCE PORTANT LE NUMÉRO SPECIFIÉ. LES RÉGLAGES DE CIRCUIT DONT L'IMPORTANCE EST CRITIQUE POUR LA SÉCURITÉ DU FONCTIONNEMENT SONT IDENTIFIÉS DANS LE PRÉSENT MANUEL. SUIVRE CES PROCÉDURES LORS DE CHAQUE REMPLACEMENT DE COMPOSANTS CRITIQUES, OU LORSQU'UN MAUVAIS FONCTIONNEMENT EST SUSPECTÉ.

Power saving function

This monitor meets the power-saving guidelines set by VESA, ENERGY STAR, and NUTEK. If the monitor is connected to a computer or video graphics board that is DPMS (Display Power Management Signaling) compliant, the monitor will automatically reduce power consumption in three stages as shown below.

Power mode	Power consumption	⏻ (power) indicator
normal operation	≤ 145 W	green
1 standby	≤ 15 W	green and orange alternate
2 suspend (sleep)*	≤ 15 W	green and orange alternate
3 active off** (deep sleep)*	Approx. 1 W	orange
power off	0 W	off

* “Sleep” and “deep sleep” are power saving modes defined by the Environmental Protection Agency.

** When your computer enters a power saving mode, the input signal is cut and NO INPUT SIGNAL appears on the screen. After a few seconds, the monitor enters a power saving mode.

DIAGNOSIS

This monitor is equipped with a self-diagnosis function. If there is a problem with your monitor or computer, the screen will go blank and the ⏻ (power) indicator will either light up green or flash orange. If the ⏻ (power) indicator is lit in orange, the computer is in power saving mode. Try pressing any key on the keyboard.

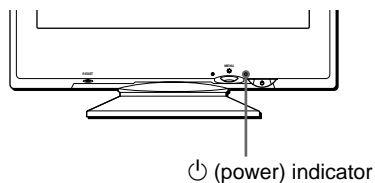

If all four color bars appear (white, red, green, blue), the monitor is working properly. Reconnect the video input cable and check the condition of your computer.

If the color bars do not appear, there is a potential monitor failure. Inform your authorized Sony dealer of the monitor's condition.

If the ⏻ (power) indicator is flashing orange

Press the ⏻ (power) button twice to turn the monitor off and then on.

If the ⏻ (power) indicator lights up green, the monitor is working properly.

If the ⏻ (power) indicator is still flashing, there is a potential monitor failure. Count the number of seconds between orange flashes of the ⏻ (power) indicator and inform your authorized Sony dealer of the monitor's condition. Be sure to note the model name and serial number of your monitor. Also note the make and model of your computer and video board.

If the ⏻ (power) indicator is green

- 1 Disconnect the video input cable or turn off the connected computer.**
- 2 Press the ⏻ (power) button twice to turn the monitor off and then on.**
- 3 Move the control button → for 2 seconds before the monitor enters power saving mode.**

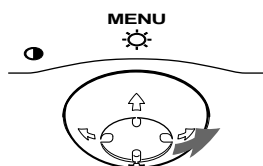

CPD-E500/E500E

TIMING SPECIFICATION

MODE AT PRODUCTION	MODE 1
RESOLUTION	1600 X 1200
CLOCK	229.500 MHz
— HORIZONTAL —	
H-FREQ	106.250 kHz
	usec
H. TOTAL	9.412
H. BLK	2.440
H. FP	0.279
H. SYNC	0.837
H. BP	1.325
H. ACTIV	6.972
— VERTICAL —	
V. FREQ(HZ)	85.000 Hz
	lines
V. TOTAL	1250
V. BLK	50
V. FP	1
V. SYNC	3
V. BP	46
V. ACTIV	1200
— SYNC —	
INT(G)	NO
EXT(H/V)/POLARITY	YES P/P
EXT(CS) /POLARITY	NO
INT/NON INT	NON INT

99.11.18 VER.

TABLE OF CONTENTS

<i>Section</i>	<i>Title</i>	<i>Page</i>
1. GENERAL		1-1
2. DISASSEMBLY		
2-1.	Cabinet Removal	2-1
2-2.	D Board Removal	2-1
2-3.	G Board Removal	2-2
2-4-1.	A Board, I/O Terminal Board Assembly Removal (CPD-E500E)	2-3
2-4-2.	A Board, Terminal Bracket Removal (CPD-E500)	2-3
2-5.	N Board Removal	2-4
2-6.	Service Position	2-4
2-7.	Bezel Assembly, H1 Board Removal	2-5
2-8.	Picture Tube Removal	2-5
2-9.	J Board Removal	2-6
2-10-1.	Harness Location (CPD-E500E)	2-7
2-10-2.	Harness Location (CPD-E500)	2-8
3. SAFETY RELATED ADJUSTMENT		3-1
4. ADJUSTMENTS		4-1
5. DIAGRAMS		
5-1.	Block Diagrams	5-1
5-2.	Frame Schematic Diagram	5-7
5-3.	Circuit Boards Location	5-9
5-4.	Schematic Diagrams and Printed Wiring Boards	5-9
(1)	Schematic Diagram of A Board	5-11
(2)	Schematic Diagrams of H1, J Boards	5-17
(3)	Schematic Diagram of D Board	5-19
(4)	Schematic Diagrams of N (Ⓐ, Ⓑ, Ⓒ) Board	5-23
(5)	Schematic Diagram of G Board	5-31
5-5.	Semiconductors	5-35
6. EXPLODED VIEWS		
6-1.	Chassis	6-1
6-2.	Picture Tube	6-2
6-3.	Packing Materials	6-3
7. ELECTRICAL PARTS LIST		7-1

Note: Hand degauss must be used on stand-by or power-off condition.

This model has an automatic earth magnetism correction function by using an earth magnetism sensor and a LCC coil. When using a hand degauss while monitor (LCC coil) is being operated, it sometimes gets magnetized, and the system may not work properly as a result.

The operating instructions mentioned here are partial abstracts from the Operating Instruction Manual. The page numbers of the Operating Instruction Manual remain as in the manual.

SECTION 1 GENERAL

Precautions

Warning on power connections

- Use the supplied power cord. If you use a different power cord, be sure that it is compatible with your local power supply.

For the customers in the U.S.A.

If you do not use the appropriate cord, this monitor will not conform to mandatory FCC standards.

Example of plug types

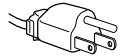

for 100 to 120 V AC



for 200 to 240 V AC

- Before disconnecting the power cord, wait at least 30 seconds after turning off the power to allow the static electricity on the screen's surface to discharge.
- After the power is turned on, the screen is demagnetized (degaussed) for about 2 seconds. This generates a strong magnetic field around the screen which may affect data stored on magnetic tapes and disks placed near the monitor. Be sure to keep magnetic recording equipment, tapes, and disks away from the monitor.

The equipment should be installed near an easily accessible outlet.

Installation

Do not install the monitor in the following places:

- on surfaces (rugs, blankets, etc.) or near materials (curtains, draperies, etc.) that may block the ventilation holes
- near heat sources such as radiators or air ducts, or in a place subject to direct sunlight
- in a place subject to severe temperature changes
- in a place subject to mechanical vibration or shock
- on an unstable surface
- near equipment which generates magnetism, such as a transformer or high voltage power lines
- near or on an electrically charged metal surface

Maintenance

- Clean the screen with a soft cloth. If you use a glass cleaning liquid, do not use any type of cleaner containing an anti-static solution or similar additive as this may scratch the screen's coating.
- Do not rub, touch, or tap the surface of the screen with sharp or abrasive items such as a ballpoint pen or screwdriver. This type of contact may result in a scratched picture tube.
- Clean the cabinet, panel and controls with a soft cloth lightly moistened with a mild detergent solution. Do not use any type of abrasive pad, scouring powder or solvent, such as alcohol or benzene.

Transportation

When you transport this monitor for repair or shipment, use the original carton and packing materials.

Use of the tilt-swivel

This monitor can be adjusted within the angles shown below. To find the center of the monitor's turning radius, align the center of the monitor's screen with the centering dots on the stand.

Hold the monitor at the bottom with both hands when you turn it horizontally or vertically. Be careful not to pinch your fingers at the back of the monitor when you tilt the monitor up vertically.

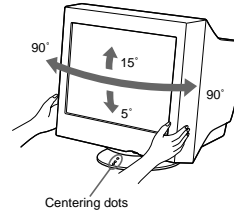

Identifying parts and controls

See the pages in parentheses for further details.

Front

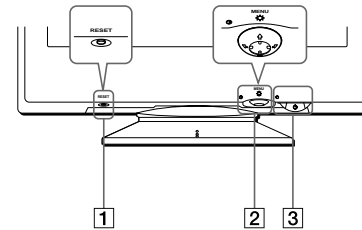

- RESET (reset) button (page 14)**
This button resets the adjustments to the factory settings.
- Control button (page 9)**
The control button is used to display the menu and make adjustments to the monitor, including brightness and contrast adjustments.
- Power switch and indicator (pages 7, 14, 18)**
This button turns the monitor on and off. The power indicator lights up in green when the monitor is turned on, and either flashes in green and orange, or lights up in orange when the monitor is in power saving mode.

Rear

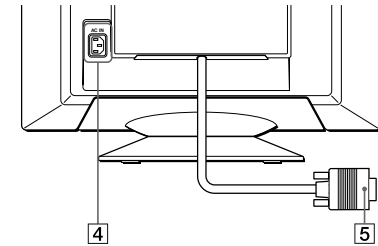

- AC IN connector (page 6)**
This connector provides AC power to the monitor.
- Video input connector (HD15) (page 6)**
This connector inputs RGB video signals (0.700 Vp-p, positive) and sync signals.

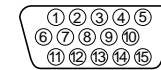

Pin No.	Signal
1	Red
2	Green (Sync on Green)
3	Blue
4	ID (Ground)
5	DDC Ground*
6	Red Ground
7	Green Ground
8	Blue Ground
9	DDC + 5V*
10	Ground
11	ID (Ground)
12	Bi-Directional Data (SDA)*
13	H. Sync
14	V. Sync
15	Data Clock (SCL)*

* DDC (Display Data Channel) is a standard of VESA.

US

Setup

Before using your monitor, check that the following accessories are included in your carton:

- Power cord (1)
- Macintosh adapter (for beige system) (1)
- Setup Disk (1)
- Warranty card (1)
- Notes on cleaning the screen's surface (1)
- This instruction manual (1)

Step 1: Connect your monitor to your computer

Turn off the monitor and computer before connecting.

Note

Do not touch the pins of the video signal cable connector as this might bend the pins.

■ Connecting to an IBM PC/AT or compatible computer

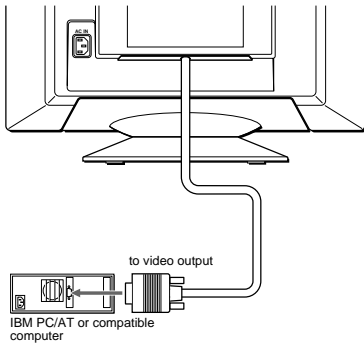

■ Connecting to a Macintosh or compatible computer

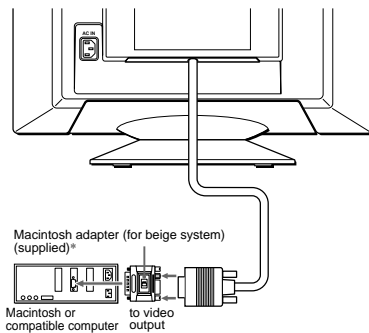

- * Connect the supplied Macintosh adapter to the computer before connecting the cable.
This adapter is compatible with Macintosh LC, Performa, Quadra, Power Macintosh, and Power Macintosh G3 series computers that have two rows of pins. If you are connecting to the other version of Power Macintosh G3 series with three rows of pins or models other than those stated above, you will need a different adapter (not supplied).

Step 2: Connect the power cord

With the monitor and computer switched off, first connect the power cord to the monitor, then connect it to a power outlet.

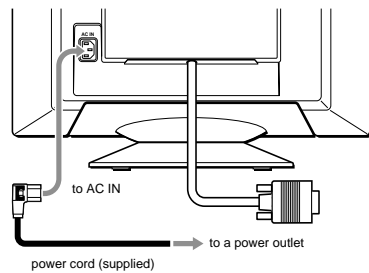

Step 3: Turn on the monitor and computer

First turn on the monitor, then turn on the computer.

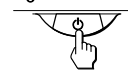

The installation of your monitor is complete.
If necessary, use the monitor's controls to adjust the picture.

If no picture appears on your screen

- Check that the monitor is correctly connected to the computer.
- If NO INPUT SIGNAL appears on the screen, confirm that your computer's graphic board is completely seated in the correct bus slot.
- If you are replacing an old monitor with this model and OUT OF SCAN RANGE appears on the screen, reconnect the old monitor. Then adjust the computer's graphic board so that the horizontal frequency is between 30 – 109 kHz, and the vertical frequency is between 48 – 160 Hz.

For more information about the on-screen messages, see "Trouble symptoms and remedies" on page 16.

For customers using Windows 95/98

To maximize the potential of your monitor, install the new model information file from the supplied Setup Disk onto your PC. This monitor complies with the "VESA DDC" Plug & Play standard. If your PC/graphics board complies with DDC, select "Plug & Play Monitor (VESA DDC)" or this monitor's model name as the monitor type in the "Control Panel" of Windows 95/98. If your PC/graphics board has difficulty communicating with this monitor, load the Setup Disk and select this monitor's model name as the monitor type.

For customers using Windows NT4.0

Monitor setup in Windows NT4.0 is different from Windows 95/98 and does not involve the selection of monitor type. Refer to the Windows NT4.0 instruction manual for further details on adjusting the resolution, refresh rate, and number of colors.

Selecting the on-screen menu language (LANG)

English, French, German, Spanish, Italian, Dutch, Swedish, Russian and Japanese versions of the on-screen menus are available. The default setting is English.

1 Press the center of the control button.

See page 9 for more information on using the control button.

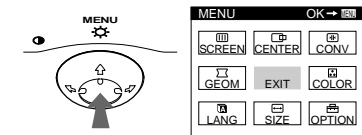

2 Move the control button to highlight LANG and press the center of the control button again.



3 Move the control button ↓/↑ to select a language.

- ENGLISH
- FRANÇAIS: French
- DEUTSCH: German
- ESPAÑOL: Spanish
- ITALIANO: Italian
- NEDERLANDS: Dutch
- SVENSKA: Swedish
- РУССКИЙ: Russian
- 日本語: Japanese

To close the menu

Press the center of the control button once to return to the main MENU, and twice to return to normal viewing. If no buttons are pressed, the menu closes automatically after about 30 seconds.

To reset to English

Press the RESET button while the LANGUAGE menu is displayed on the screen.

US

Customizing Your Monitor

You can make numerous adjustments to your monitor using the on-screen menu.

Navigating the menu

Press the center of the control button to display the main MENU on your screen. See page 9 for more information on using the control button.

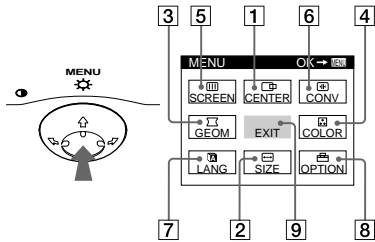

Use the control button to select one of the following menus.

1 CENTER (page 10)

Selects the CENTER menu to adjust the picture's centering, size or zoom.

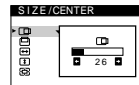

2 SIZE (page 10)

Selects the SIZE menu to adjust the picture's size, centering or zoom.

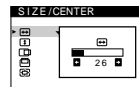

3 GEOM (page 10)

Select the GEOM menu to adjust the picture's rotation and shape.

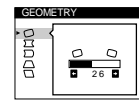

4 COLOR (page 12)

Select the COLOR menu to adjust the picture's color temperature. You can use this to match the monitor's colors to a printed picture's colors.

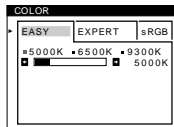

5 SCREEN (page 11)

Select the SCREEN menu to adjust the picture's quality. You can adjust the landing and moire cancellation effect.

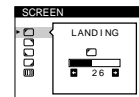

6 CONV (page 11)

Select the CONV menu to adjust the picture's horizontal and vertical convergence.

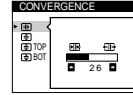

7 LANG (page 7)

Select the LANG menu to choose the on-screen menu's language.



8 OPTION (page 13)

Select the OPTION menu to adjust the monitor's options. The options include:

- degaussing the screen
- changing the on-screen menu position
- locking the controls

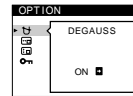

9 EXIT

Select EXIT to close the menu.

■ Displaying the current input signal

The horizontal and vertical frequencies of the current input signal are displayed in the main MENU. If the signal matches one of this monitor's factory preset modes, the resolution is also displayed.

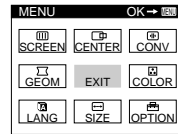

the resolution of the current input signal

(68.7kHz / 85Hz)

the horizontal and vertical frequencies of the current input signal

■ Using the control button

1 Display the main MENU.

Press the center of the control button to display the main MENU on your screen.

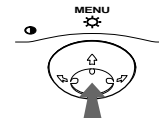

2 Select the menu you want to adjust.

Highlight the desired menu by moving the control button towards the rear to go up (↑), towards the front to go down (↓), and left (←) or right (→) to move sideways.

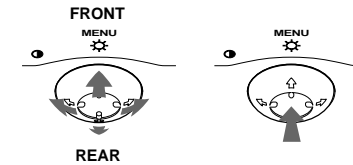

3 Adjust the menu.

Move the control button left (←) or right (→) to make the adjustment.

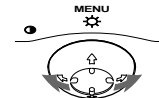

4 Close the menu.

Press the center of the control button once to return to the main MENU, and twice to return to normal viewing. If no buttons are pressed, the menu closes automatically after about 30 seconds.

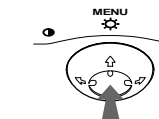

■ Resetting the adjustments

Press the RESET button. See page 14 for more information on resetting the adjustments.

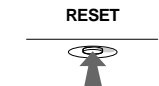

Adjusting the brightness and contrast

Brightness and contrast adjustments are made using a separate BRIGHTNESS/CONTRAST menu. These settings are stored in memory for all input signals.

1 Move the control button in any direction.

The BRIGHTNESS/CONTRAST menu appears on the screen.

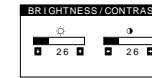

2 Move the control button ↓/↑ to adjust the brightness (☉), and ←/→ to adjust the contrast (☉).

If you are using the sRGB mode

If you selected the sRGB mode in the COLOR menu, the following BRIGHTNESS/CONTRAST menu appears on the screen.

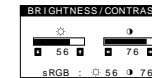



For more information about using the sRGB mode, see "Adjusting the color of the picture (COLOR)" on page 12.

The menu automatically disappears after about 3 seconds.

US



Adjusting the size of the picture (SIZE)

This setting is stored in memory for the current input signal.

- 1 Press the center of the control button.**
The main MENU appears on the screen.
- 2 Move the control button to highlight  SIZE and press the center of the control button again.**
The SIZE/CENTER menu appears on the screen.
- 3 First move the control button \uparrow/\downarrow to select  for horizontal adjustment, or  for vertical adjustment. Then move the control button \leftarrow/\rightarrow to adjust the size.**



Adjusting the centering of the picture (CENTER)

This setting is stored in memory for the current input signal.

- 1 Press the center of the control button.**
The main MENU appears on the screen.
- 2 Move the control button to highlight  CENTER and press the center of the control button again.**
The SIZE/CENTER menu appears on the screen.
- 3 First move the control button \uparrow/\downarrow to select  for horizontal adjustment, or  for vertical adjustment. Then move the control button \leftarrow/\rightarrow to adjust the centering.**

Enlarging or reducing the picture (ZOOM)

This setting is stored in memory for the current input signal.

- 1 Press the center of the control button.**
The main MENU appears on the screen.
- 2 Move the control button to highlight  SIZE or  CENTER and press the center of the control button again.**
The SIZE/CENTER menu appears on the screen.
- 3 Move the control button \uparrow/\downarrow to select  (zoom), and move \leftarrow/\rightarrow to enlarge or reduce the picture.**

Note





Adjustment stops when either the horizontal or vertical size reaches its maximum or minimum value.

Adjusting the shape of the picture (GEOM)

The GEOM settings allow you to adjust the rotation and shape of the picture.

The  (rotation) setting is stored in memory for all input signals. All other settings are stored in memory for the current input signal.

- 1 Press the center of the control button.**
The main MENU appears on the screen.
- 2 Move the control button to highlight  GEOM and press the center of the control button again.**
The GEOMETRY menu appears on the screen.
- 3 First move the control button \uparrow/\downarrow to select the desired adjustment item. Then move the control button \leftarrow/\rightarrow to make the adjustment.**





Select	To
	rotate the picture
	expand or contract the picture sides
	shift the picture sides to the left or right
	adjust the picture width at the top of the screen
	shift the picture to the left or right at the top of the screen

Adjusting the convergence (CONV)

The CONV settings allow you to adjust the quality of the picture by controlling the convergence. The convergence refers to the alignment of the red, green, and blue color signals. If you see red or blue shadows around letters or lines, adjust the convergence.

These settings are stored in memory for all input signals.

- 1 Press the center of the control button.**
The main MENU appears on the screen.
- 2 Move the control button to highlight  CONV and press the center of the control button again.**
The CONVERGENCE menu appears on the screen.
- 3 First move the control button \uparrow/\downarrow to select the desired adjustment item. Then move the control button \leftarrow/\rightarrow to make the adjustment.**







Select	To
	horizontally shift red or blue shadows
	vertically shift red or blue shadows
 TOP V CONVER TOP	vertically shift red or blue shadows at the top of the screen
 BOT V CONVER BOTTOM	vertically shift red or blue shadows at the bottom of the screen

Adjusting the quality of the picture (SCREEN)

The SCREEN settings allow you to adjust the quality of the picture by controlling the moire and landing.

- If the color is irregular at the corners of the screen, adjust the landing.
 - If elliptical or wavy patterns appear on the screen, cancel the moire.
- The CANCEL MOIRE and MOIRE ADJUST settings are stored in memory for the current input signal. All other settings are stored in memory for all input signals.

- 1 Press the center of the control button.**
The main MENU appears on the screen.
- 2 Move the control button to highlight  SCREEN and press the center of the control button again.**
The SCREEN menu appears on the screen.
- 3 First move the control button \uparrow/\downarrow to select the desired adjustment item. Then move the control button \leftarrow/\rightarrow to make the adjustment.**

Select	To
 LANDING	reduce any color irregularities in the screen's top left corner to a minimum.
 LANDING	reduce any color irregularities in the screen's top right corner to a minimum.
 LANDING	reduce any color irregularities in the screen's bottom left corner to a minimum.
 LANDING	reduce any color irregularities in the screen's bottom right corner to a minimum.
 CANCEL MOIRE*	turn the moire cancellation function ON or OFF.  (MOIRE ADJUST) appears in the menu when you select ON.
 MOIRE ADJUST	adjust the degree of moire cancellation until the moire is at a minimum.

- Moire is a type of natural interference which produces soft, wavy lines on your screen. It may appear due to interference between the pattern of the picture on the screen and the phosphor pitch pattern of the monitor.

Example of moire

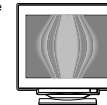

Note

The picture may become fuzzy when CANCEL MOIRE is set to ON.

Adjusting the color of the picture (COLOR)

The COLOR settings allow you to adjust the picture's color temperature by changing the color level of the white color field. Colors appear reddish if the temperature is low, and bluish if the temperature is high. This adjustment is useful for matching the monitor's color to a printed picture's colors. These settings are stored in memory for all input signals.

- 1 Press the center of the control button.
The main MENU appears on the screen.
- 2 Move the control button to highlight **COLOR** and press the center of the control button again.
The COLOR menu appears on the screen.
- 3 Move the control button **←/→** to select the adjustment mode.
There are three types of adjustment modes, EASY, EXPERT and sRGB.
- 4 First move the control button **↓/↑** to select the desired adjustment item. Then move the control button **←/→** to make the adjustment.
Adjust the selected mode according to the following instructions.

EASY mode

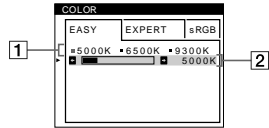

- 1 Move the control button **↓/↑** to select the color temperature row **[1]**. Then move the control button **←/→** to select a color temperature.
The preset color temperatures are 5000K, 6500K, and 9300K. Since the default setting is 9300K, the whites will change from a bluish hue to a reddish hue as the temperature is lowered to 6500K and 5000K.
- 2 If necessary, fine tune the color temperature. Move the control button **↓/↑** to select the color temperature row **[2]**. Then move the control button **←/→** to fine tune the color temperature.
If you fine tune the color temperature, the new color settings are stored in memory for each of the three color temperatures and item **[1]** of the on-screen menu changes as follows.
 - [5000K]→[**[1]**]
 - [6500K]→[**[2]**]
 - [9300K]→[**[3]**]

EXPERT mode

You can make additional adjustments to the color in greater detail by selecting the EXPERT mode.

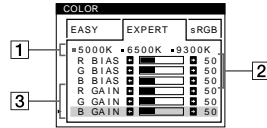

- 1 Move the control button **↓/↑** to select the color temperature row **[1]**. Then move the control button **←/→** to select a color temperature.
- 2 Move the control button **↓/↑** to select the adjustment item **[2]**. Then move the control button **←/→** to adjust the BIAS (black level).
This adjusts the dark areas of an image.
- 3 Move the control button **↓/↑** to select the adjustment item **[3]**. Then move the control button **←/→** to adjust the GAIN (white level).
This adjusts the light areas of an image.

You can adjust the R (red), G (green), B (blue) component of the input signal when making changes to items **[2]** and **[3]**.

If you fine tune the color temperature, the new color settings are stored in memory for each of the three color temperatures and item **[1]** of the on-screen menu change as follows.

- [5000K]→[**[1]**]
- [6500K]→[**[2]**]
- [9300K]→[**[3]**]

sRGB mode

The sRGB color setting is an industry standard color space protocol designed to correlate the displayed and printed colors of sRGB compliant computer products. To adjust the colors to the sRGB profile, simply select the sRGB mode in the COLOR menu. However, in order to display the sRGB colors correctly ($\gamma=2.2$, 6500K), you must set your computer to the sRGB profile and adjust the brightness (**[☼]**) and contrast (**[☉]**) to the numbers shown in the menu. For information on how to change the brightness (**[☼]**) and contrast (**[☉]**), see page 9.

Note

Your computer and other connected products (such as a printer), must be sRGB compliant.



Additional settings (OPTION)

You can manually degauss (demagnetize) the monitor, change the menu position, and lock the controls.

- 1 Press the center of the control button.
The main MENU appears on the screen.
- 2 Move the control button to highlight **OPTION** and press the center of the control button again.
The OPTION menu appears on the screen.
- 3 Move the control button **↓/↑** to select the desired adjustment item.
Adjust the selected item according to the following instructions.

Degaussing the screen

The monitor is automatically demagnetized (degaussed) when the power is turned on.

To manually degauss the monitor, first move the control button **↓/↑** to select **[☼]** (DEGAUSS). Then move the control button **→**.

The screen is degaussed for about 2 seconds. If a second degauss cycle is needed, allow a minimum interval of 20 minutes for the best result.

Changing the menu's position

Change the menu's position if it is blocking an image on the screen.

To change the menu's on-screen position, first move the control button **↓/↑** to select **[☼]** (OSD H POSITION) for horizontal adjustment, or **[☽]** (OSD V POSITION) for vertical adjustment. Then move the control button **←/→** to shift the on-screen menu.

Locking the controls

To protect adjustment data by locking the controls, first move the control button **↓/↑** to select **[☼]** (CONTROL LOCK). Then move the control button **→**, to select ON. Only the **[☼]** (power) switch, EXIT, and **[☼]** (CONTROL LOCK) of the **[☼]** OPTION menu will operate. If any other items are selected, the **[☼]** mark appears on the screen.

To cancel the control lock

Repeat the procedure above and set **[☼]** (CONTROL LOCK) to OFF.

US

Resetting the adjustments

This monitor has the following three reset methods. Use the RESET button to reset the adjustments.

RESET



Resetting a single adjustment item

Use the control button to select the adjustment item you want to reset, and press the RESET button.

Resetting all of the adjustment data for the current input signal

Press the RESET button when no menu is displayed on the screen. Note that the following items are not reset by this method:

- on-screen menu language (page 7)
- adjustment mode in the COLOR menu (EASY, EXPERT, sRGB) (page 12)
- on-screen menu position (page 13)
- control lock (page 13)

Resetting all of the adjustment data for all input signals

Press and hold the RESET button for more than two seconds.

Note

The RESET button does not function when  (CONTROL LOCK) is set to ON.

Technical Features

Preset and user modes

When the monitor receives an input signal, it automatically matches the signal to one of the factory preset modes stored in the monitor's memory to provide a high quality picture at the center of the screen. (See Appendix for a list of the factory preset modes.) For input signals that do not match one of the factory preset modes, the digital Multiscan technology of this monitor ensures that a clear picture appears on the screen for any timing in the monitor's frequency range (horizontal: 30 – 109 kHz, vertical: 48 – 160 Hz). If the picture is adjusted, the adjustment data is stored as a user mode and automatically recalled whenever the same input signal is received.

Note for Windows users

For Windows users, check your video board manual or the utility program which comes with your graphic board and select the highest available refresh rate to maximize monitor performance.

Power saving function

This monitor meets the power-saving guidelines set by VESA, ENERGY STAR, and NUTEK. If the monitor is connected to a computer or video graphics board that is DPMS (Display Power Management Signaling) compliant, the monitor will automatically reduce power consumption in three stages as shown below.

Power mode	Power consumption	 (power) indicator
normal operation	≤ 145 W	green
1 standby	≤ 15 W	green and orange alternate
2 suspend (sleep)*	≤ 15 W	green and orange alternate
3 active off** (deep sleep)*	Approx. 1 W	orange
power off	0 W	off

* "Sleep" and "deep sleep" are power saving modes defined by the Environmental Protection Agency.

** When your computer enters a power saving mode, the input signal is cut and NO INPUT SIGNAL appears on the screen. After a few seconds, the monitor enters a power saving mode.

Troubleshooting

Before contacting technical support, refer to this section.

If thin lines appear on your screen (damper wires)

The lines you are experiencing on your screen are normal for the Trinitron monitor and are not a malfunction. These are shadows from the damper wires used to stabilize the aperture grille and are most noticeable when the screen's background is light (usually white). The aperture grille is the essential element that makes a Trinitron picture tube unique by allowing more light to reach the screen, resulting in a brighter, more detailed picture.

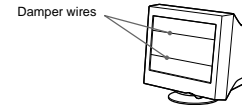

On-screen messages

If there is something wrong with the input signal, one of the following messages appears on the screen.

If NO INPUT SIGNAL appears on the screen

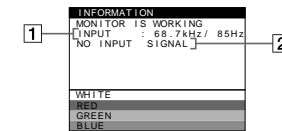

1 The frequencies of the current input signal

If the monitor recognizes the frequencies of the current input signal, the horizontal and vertical frequencies are displayed.

2 The input signal condition NO INPUT SIGNAL

This indicates that no signal is input.

If OUT OF SCAN RANGE appears on the screen

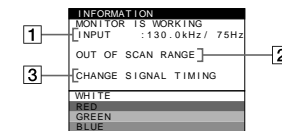

1 The frequencies of the current input signal

If the monitor recognizes the frequencies of the current input signal, the horizontal and vertical frequencies are displayed.

2 The input signal condition OUT OF SCAN RANGE

This indicates that the input signal is not supported by the monitor's specifications.

3 The remedies

CHANGE SIGNAL TIMING appears on the screen. If you are replacing an old monitor with this monitor, reconnect the old monitor. Then adjust the computer's graphic board so that the horizontal frequency is between 30 - 109 kHz, and the vertical frequency is between 48 - 160 Hz.

For more information, see "Trouble symptoms and remedies" on page 16

US

Trouble symptoms and remedies

If the problem is caused by the connected computer or other equipment, please refer to the connected equipment's instruction manual. Use the self-diagnosis function (page 18) if the following recommendations do not resolve the problem.

Symptom	Check these items
No picture	
If the ⏻ (power) indicator is not lit	<ul style="list-style-type: none"> Check that the power cord is properly connected. Check that the ⏻ (power) switch is in the "on" position.
If the NO INPUT SIGNAL message appears on the screen, or if the ⏻ (power) indicator is either orange or alternating between green and orange	<ul style="list-style-type: none"> Check that the video signal cable is properly connected and all plugs are firmly seated in their sockets. (page 6). Check that the HD15 video input connector's pins are not bent or pushed in. <p>■ Problems caused by the connected computer or other equipment</p> <ul style="list-style-type: none"> The computer is in power saving mode. Try pressing any key on the computer keyboard or moving the mouse. Check that the computer's power is "on." Check that the graphic board is completely seated in the proper bus slot.
If the OUT OF SCAN RANGE message appears on the screen	<p>■ Problems caused by the connected computer or other equipment</p> <ul style="list-style-type: none"> Check that the video frequency range is within that specified for the monitor. If you replaced an old monitor with this monitor, reconnect the old monitor and adjust the frequency range to the following. Horizontal: 30 – 109 kHz Vertical: 48 – 160 Hz
If no message is displayed and the ⏻ (power) indicator is green or flashing orange	<ul style="list-style-type: none"> Use the Self-diagnosis function (page 18).
If using Windows 95/98	<ul style="list-style-type: none"> If you replaced an old monitor with this monitor, reconnect the old monitor and do the following. Install the Setup Disk (page 7) and select this monitor ("CPD-E500") from among the Sony monitors in the Windows 95/98 monitor selection screen.
If using a Macintosh system	<ul style="list-style-type: none"> Check that the supplied Macintosh adapter and the video signal cable are properly connected (page 6).
Picture flickers, bounces, oscillates, or is scrambled	<ul style="list-style-type: none"> Isolate and eliminate any potential sources of electric or magnetic fields such as other monitors, laser printers, electric fans, fluorescent lighting, or televisions. Move the monitor away from power lines or place a magnetic shield near the monitor. Try plugging the monitor into a different AC outlet, preferably on a different circuit. Try turning the monitor 90° to the left or right. <p>■ Problems caused by the connected computer or other equipment</p> <ul style="list-style-type: none"> Check your graphics board manual for the proper monitor setting. Confirm that the graphics mode (VESA, Macintosh 21" Color, etc.) and the frequency of the input signal are supported by this monitor (Appendix). Even if the frequency is within the proper range, some graphics boards may have a sync pulse that is too narrow for the monitor to sync correctly. Adjust the computer's refresh rate (vertical frequency) to obtain the best possible picture.
Picture is fuzzy	<ul style="list-style-type: none"> Adjust the brightness and contrast (page 9). Degauss the monitor* (page 13). If CANCEL MOIRE is ON, the picture may become fuzzy. Decrease the moire cancellation effect or set CANCEL MOIRE to OFF (page 11).

Symptom	Check these items
Picture is ghosting	<ul style="list-style-type: none"> Eliminate the use of video cable extensions and/or video switch boxes. Check that all plugs are firmly seated in their sockets.
Picture is not centered or sized properly	<ul style="list-style-type: none"> Adjust the size (page 10) or centering (page 10). Note that some video modes do not fill the screen to the edges.
Edges of the image are curved	<ul style="list-style-type: none"> Adjust the geometry (page 10).
Wavy or elliptical pattern (moire) is visible	<ul style="list-style-type: none"> Set CANCEL MOIRE to ON and adjust the degree of moire cancellation until the moire is at a minimum (page 11). <p>■ Problems caused by the connected computer or other equipment</p> <ul style="list-style-type: none"> Change your desktop pattern.
Color is not uniform	<ul style="list-style-type: none"> Degauss the monitor* (page 13). If you place equipment that generates a magnetic field, such as a speaker, near the monitor, or if you change the direction the monitor faces, color may lose uniformity. Adjust the landing (page 11).
White does not look white	<ul style="list-style-type: none"> Adjust the color temperature (page 12).
Letters and lines show red or blue shadows at the edges	<ul style="list-style-type: none"> Adjust the convergence (page 11).
Monitor buttons do not operate (⏻ appears on the screen)	<ul style="list-style-type: none"> If the control lock is set to ON, set it to OFF (page 13).
A hum is heard right after the power is turned on	<ul style="list-style-type: none"> This is the sound of the auto-degauss cycle. When the power is turned on, the monitor is automatically degaussed for two seconds.

* If a second degauss cycle is needed, allow a minimum interval of 20 minutes for the best result. A humming noise may be heard, but this is not a malfunction.

Displaying this monitor's name, serial number, and date of manufacture.

While the monitor is receiving a video signal, press and hold the center of the control button for more than five seconds to display this monitor's information box.

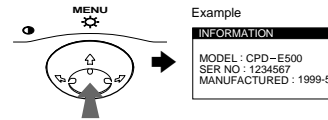



If the problem persists, call your authorized Sony dealer and give the following information.

- Model name: CPD-E500
- Serial number
- Name and specifications of your computer and graphics board.



US

Self-diagnosis function

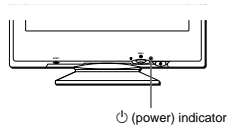
This monitor is equipped with a self-diagnosis function. If there is a problem with your monitor or computer, the screen will go blank and the  (power) indicator will either light up green or flash orange. If the  (power) indicator is lit in orange, the computer is in power saving mode. Try pressing any key on the keyboard.



If the (power) indicator is green

- 1 Disconnect the video input cable or turn off the connected computer.
- 2 Press the  (power) button twice to turn the monitor off and then on.
- 3 Move the control button  for 2 seconds before the monitor enters power saving mode.

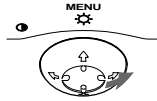



If all four color bars appear (white, red, green, blue), the monitor is working properly. Reconnect the video input cable and check the condition of your computer.

If the color bars do not appear, there is a potential monitor failure. Inform your authorized Sony dealer of the monitor's condition.

If the (power) indicator is flashing orange

Press the  (power) button twice to turn the monitor off and then on.

If the  (power) indicator lights up green, the monitor is working properly.

If the  (power) indicator is still flashing, there is a potential monitor failure. Count the number of seconds between orange flashes of the  (power) indicator and inform your authorized Sony dealer of the monitor's condition. Be sure to note the model name and serial number of your monitor. Also note the make and model of your computer and video board.

Specifications

CRT	0.24 mm aperture grille pitch 21 inches measured diagonally 90-degree deflection FD Trinitron
Viewable image size	Approx. 403.8 × 302.2 mm (w/h) (16 × 12 inches) 19.8" viewing image
Resolution	
Maximum	Horizontal: 2048 dots Vertical: 1536 lines
Recommended	Horizontal: 1600 dots Vertical: 1200 lines
Standard image area	Approx. 388 × 291 mm (w/h) (15 ³ / ₈ × 11 ¹ / ₂ inches) or Approx. 364 × 291 mm (w/h) (14 ³ / ₈ × 11 ¹ / ₂ inches)
Deflection frequency*	Horizontal: 30 to 109 kHz Vertical: 48 to 160 Hz
AC input voltage/current	100 to 240 V, 50 – 60 Hz, 2.0 – 1.0 A
Power consumption	Approx. 145 W
Dimensions	Approx. 497 × 480 × 478 mm (w/h/d) (19 ⁵ / ₈ × 19 × 18 ⁷ / ₈ inches)
Mass	Approx. 32 kg (70 lb 9 oz)
Plug and Play	DDC1/2B/2Bi, GTF**
Supplied accessories	See page 6

- * Recommended horizontal and vertical timing condition
- Horizontal sync width duty should be more than 4.8% of total horizontal time or 0.8 μs, whichever is larger.
 - Horizontal blanking width should be more than 2.3 μsec.
 - Vertical blanking width should be more than 450 μsec.
- ** If the input signal is Generalized Timing Formula (GTF) compliant, the GTF feature of the monitor will automatically provide an optimal image for the screen.

Design and specifications are subject to change without notice.

SECTION 2 DISASSEMBLY

2-1. CABINET REMOVAL

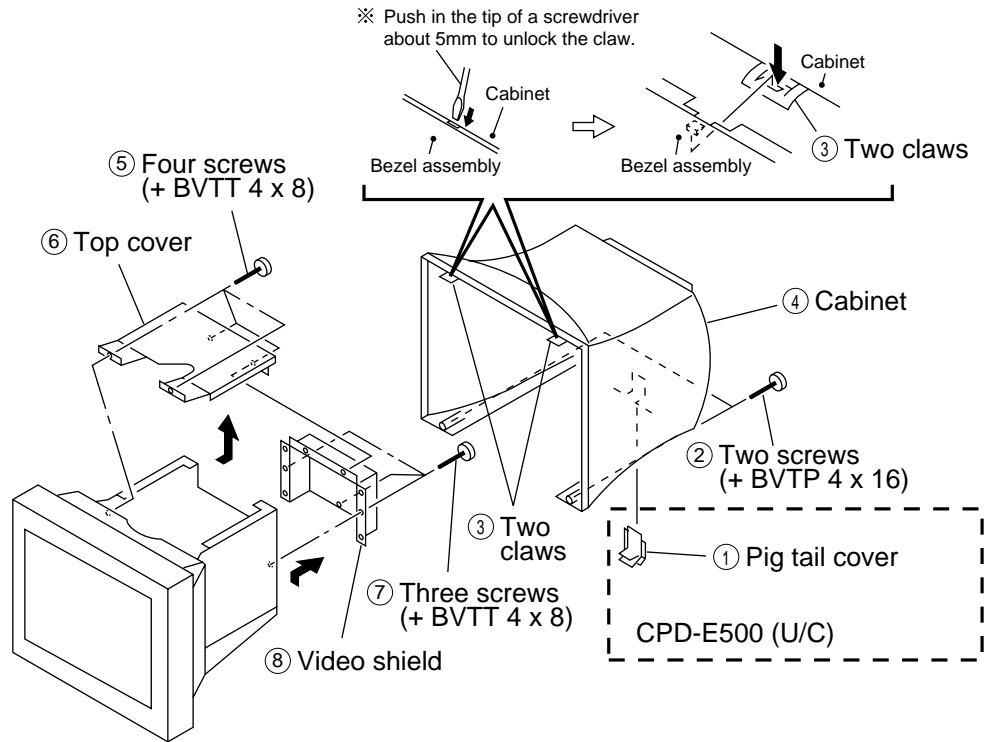

2-2. D BOARD REMOVAL

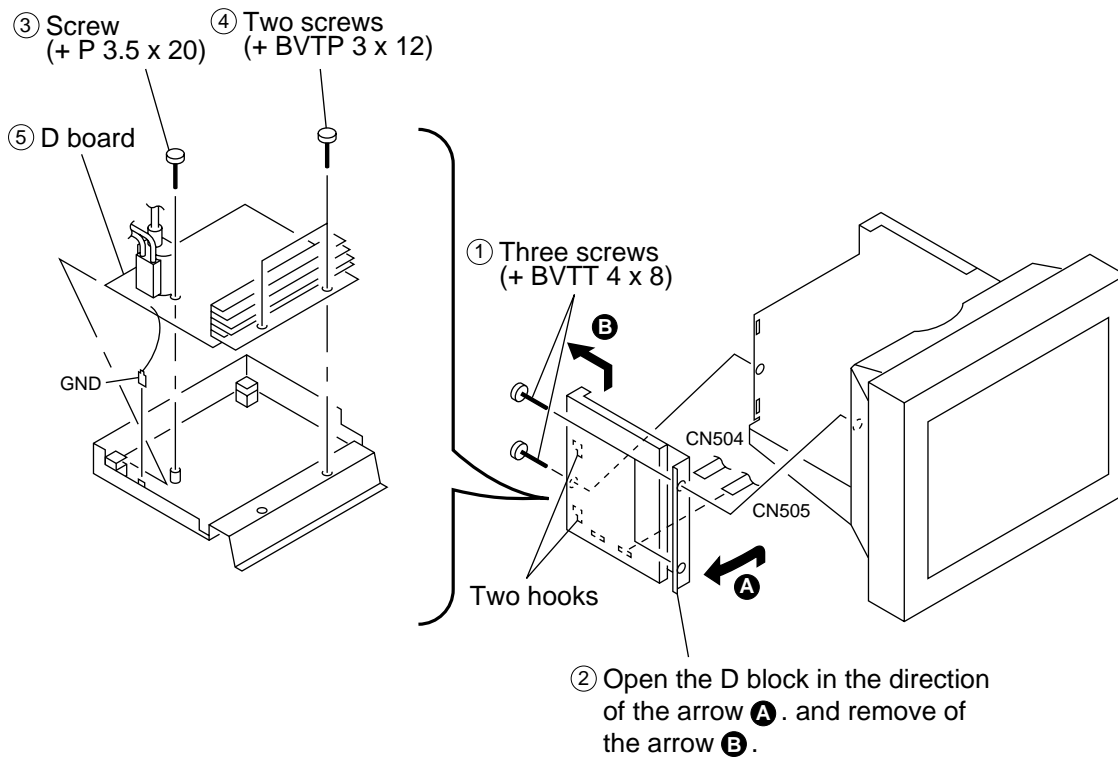

2-3. G BOARD REMOVAL

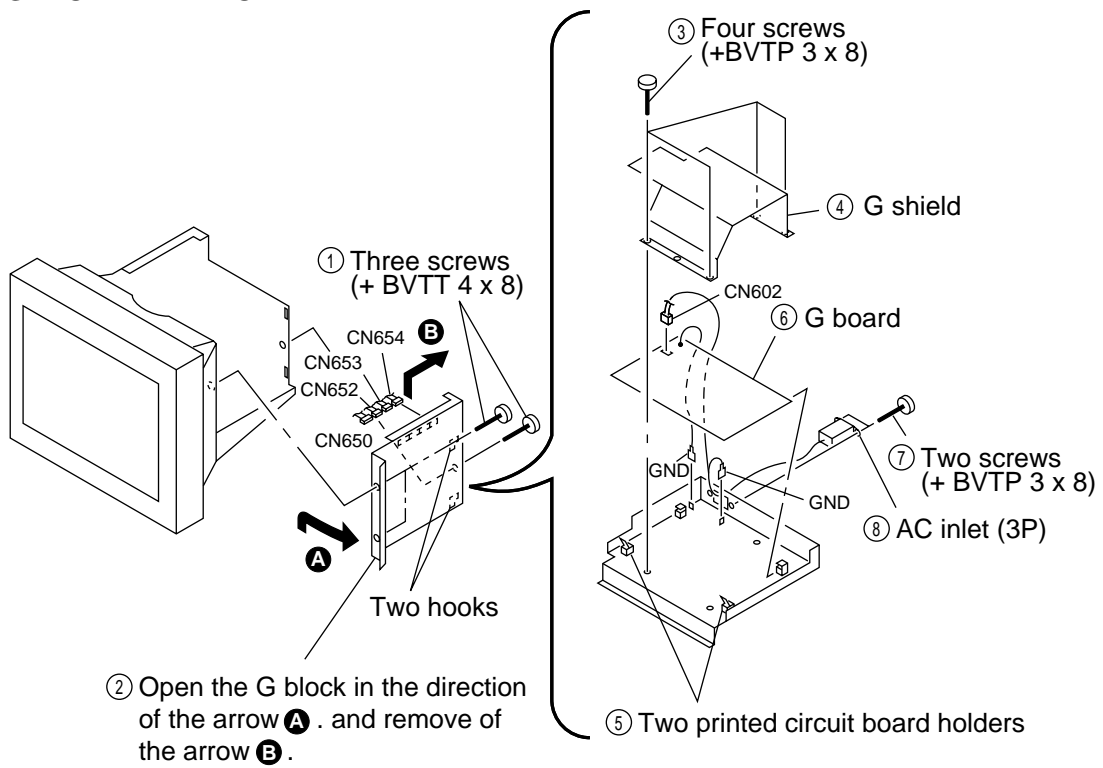

2-4-1. A BOARD, I/O TERMINAL BOARD ASSEMBLY REMOVAL (CPD-E500E)

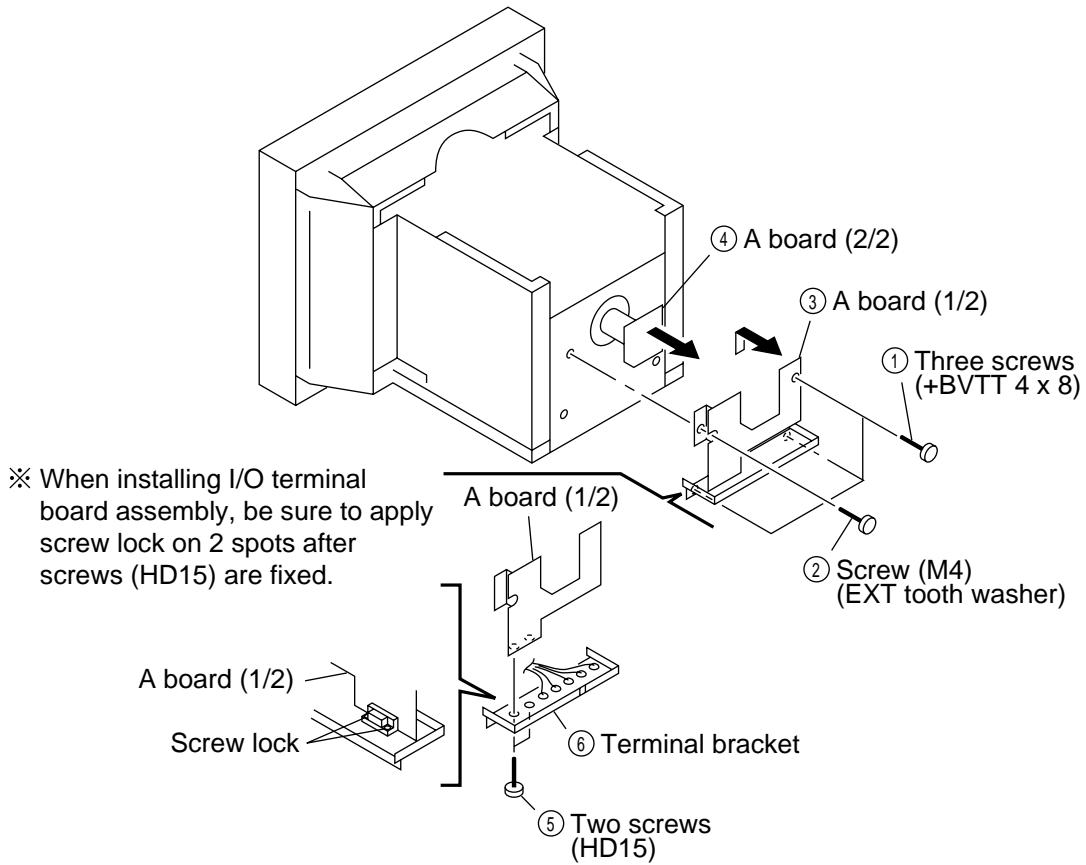

2-4-2. A BOARD, TERMINAL BRACKET REMOVAL (CPD-E500)

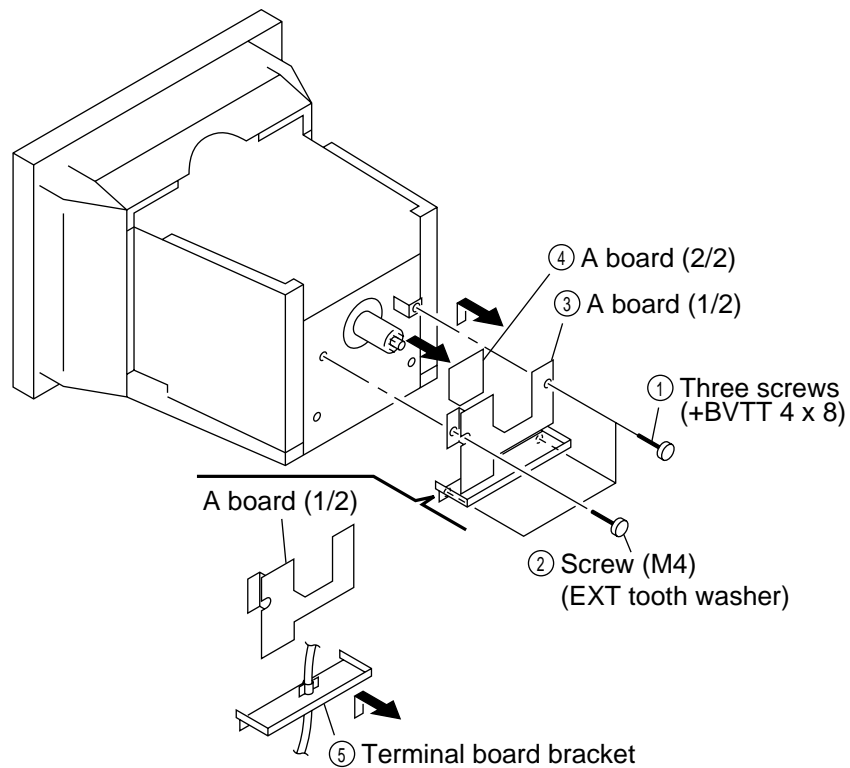

2-5. N BOARD REMOVAL

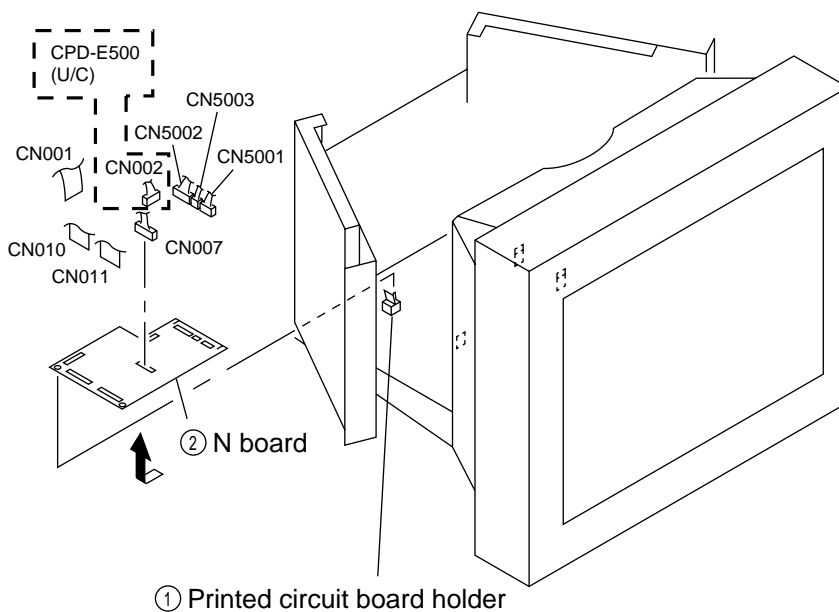

2-6. SERVICE POSITION

CAUTION : SHORT

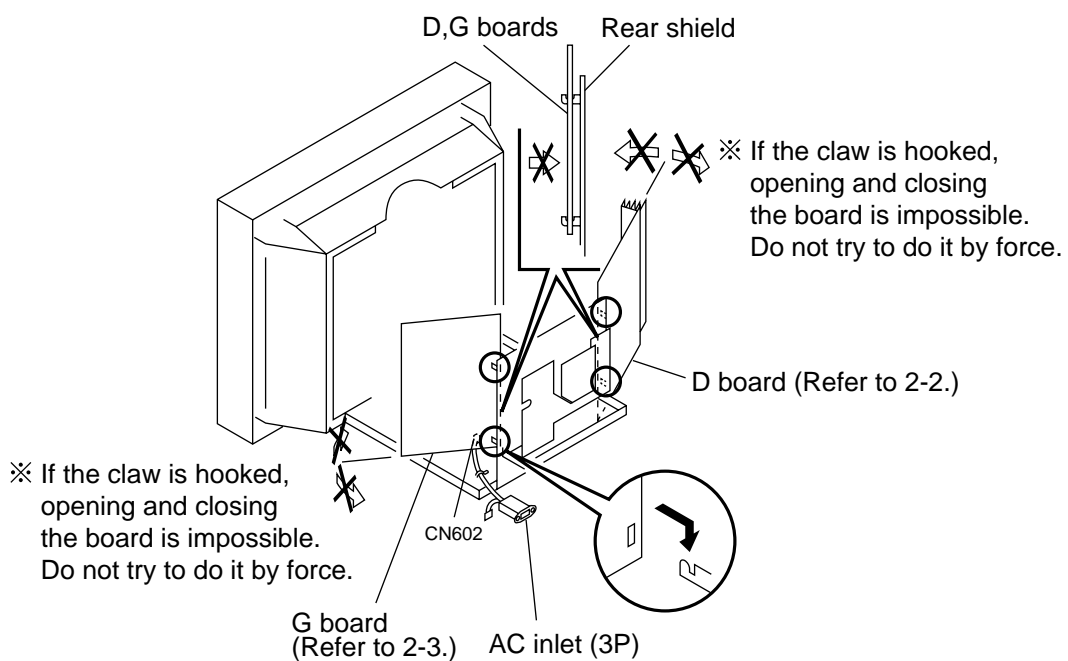

2-7. BEZEL ASSEMBLY, H1 BOARD REMOVAL

① Before removing the bezel assembly, secure the picture tube by attaching two screws to the picture tube shield at the positions shown with an arrow (diagonal two places) to prevent the picture tube from falling. (Use the screws +BVTT 4 x 8 that fix top cover.)

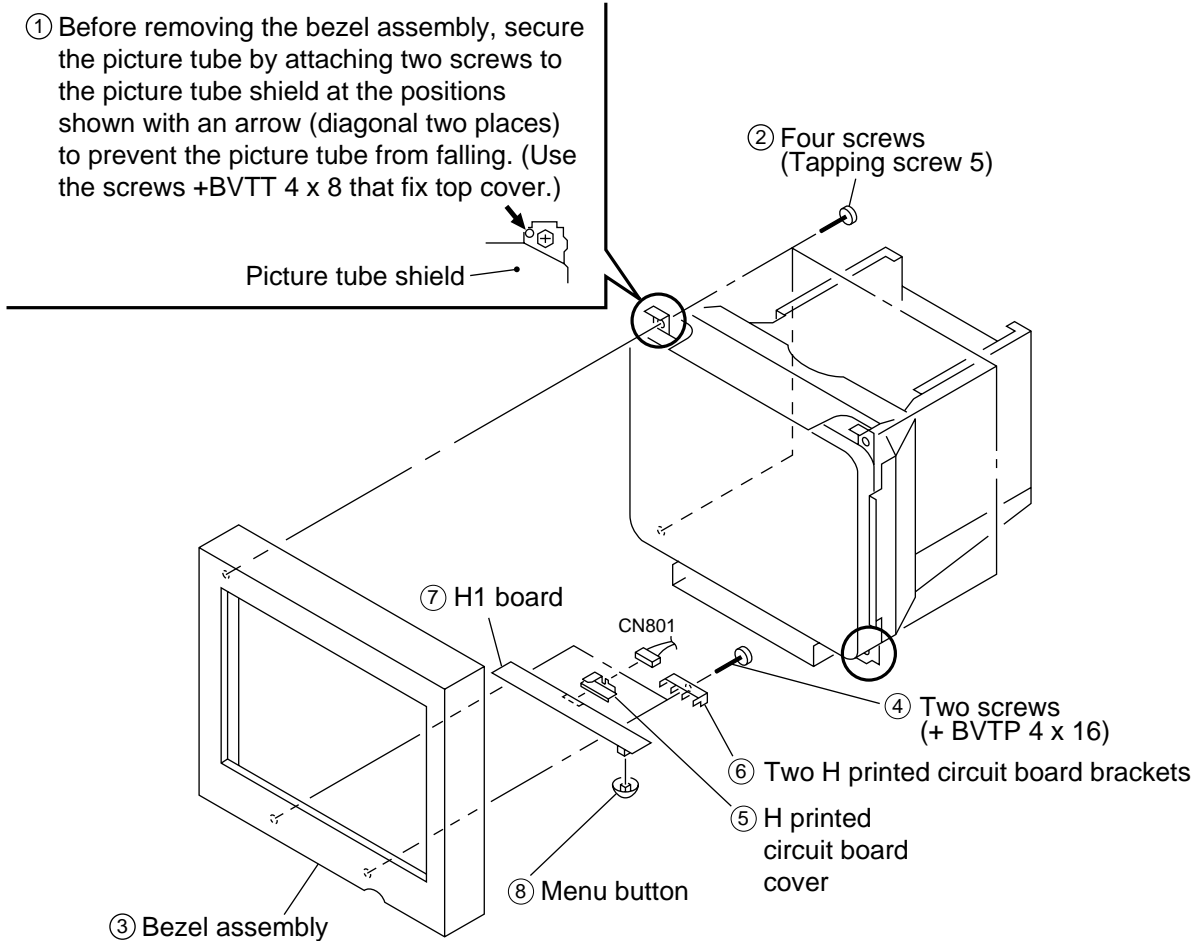

2-8. PICTURE TUBE REMOVAL

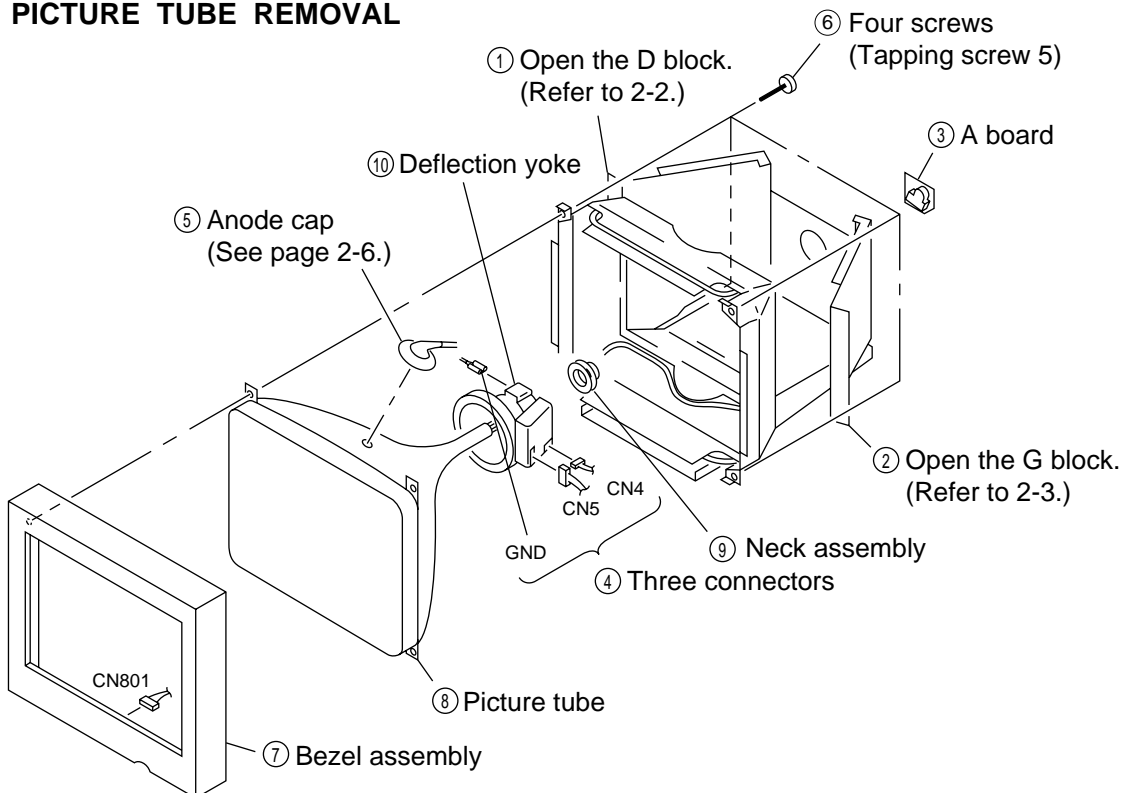

2-9. J BOARD REMOVAL

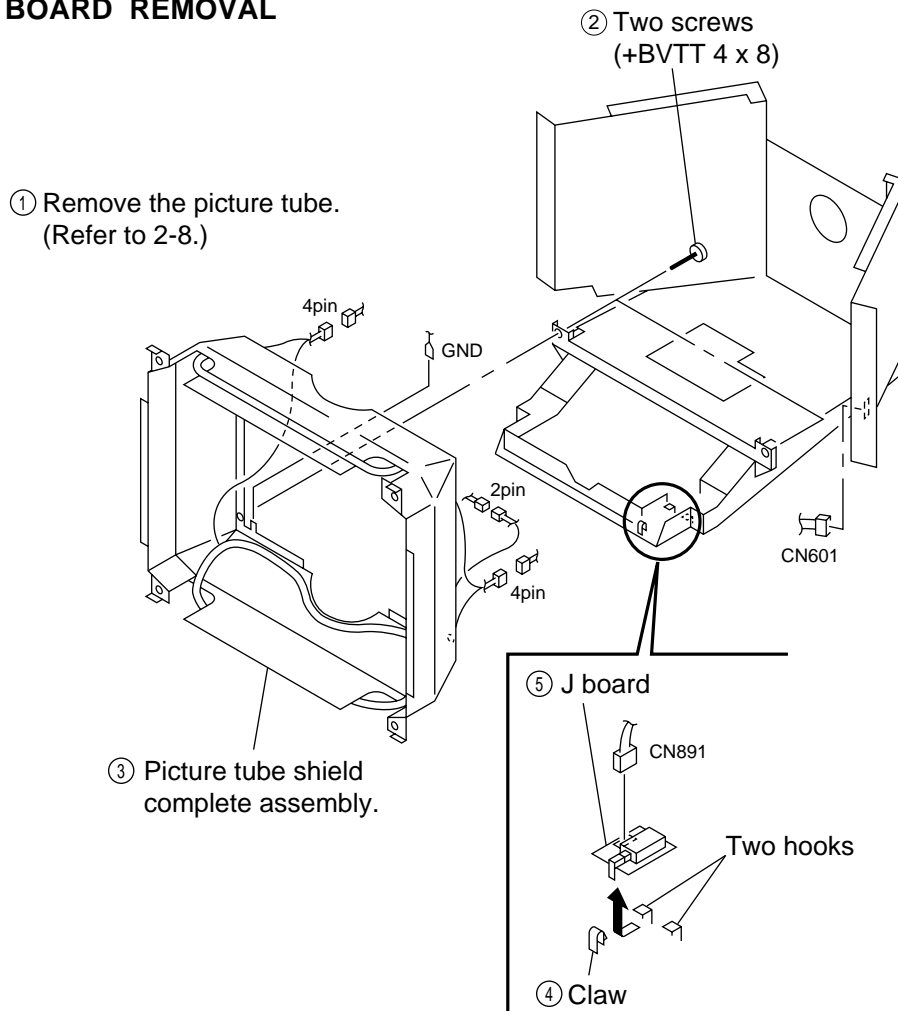

• REMOVAL OF ANODE-CAP

NOTE: Short circuit the anode of the picture tube and the anode cap to the metal chassis, CRT shield or carbon painted on the CRT, after removing the anode.

• REMOVING PROCEDURES

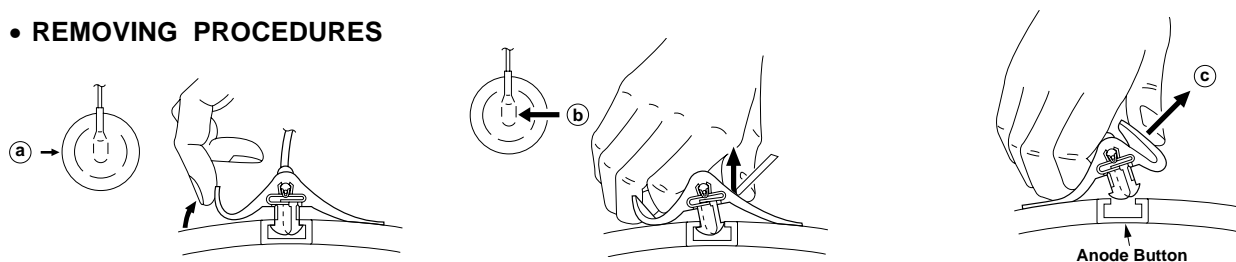

- ① Turn up one side of the rubber cap in the direction indicated by the arrow (a).
- ② Using a thumb pull up the rubber cap firmly in the direction indicated by the arrow (b).
- ③ When one side of the rubber cap is separated from the anode button, the anode-cap can be removed by turning up the rubber cap and pulling up it in the direction of the arrow (c).

• HOW TO HANDLE AN ANODE-CAP

- ① Don't scratch the surface of anode-caps with sharp shaped material!
- ② Don't press the rubber hardly not to damage inside of anode-caps!
A material fitting called as shatter-hook terminal is built in the rubber.
- ③ Don't turn the foot of rubber over hardly!
The shatter-hook terminal will stick out or damage the rubber.

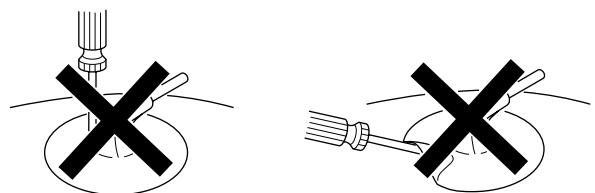

2-10-1. HARNESS LOCATION (CPD-E500E)

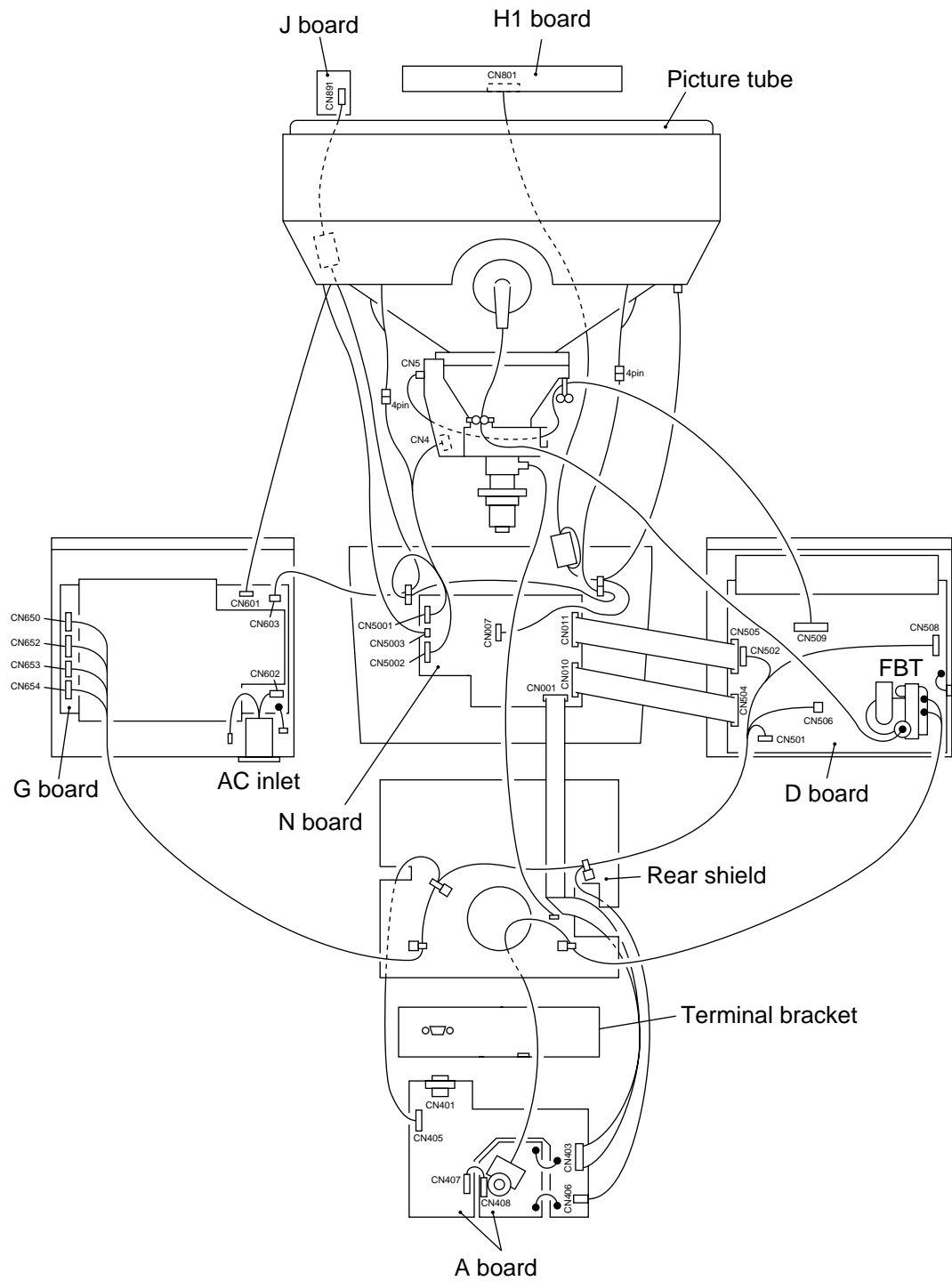

2-10-2. HARNESS LOCATION (CPD-E500)

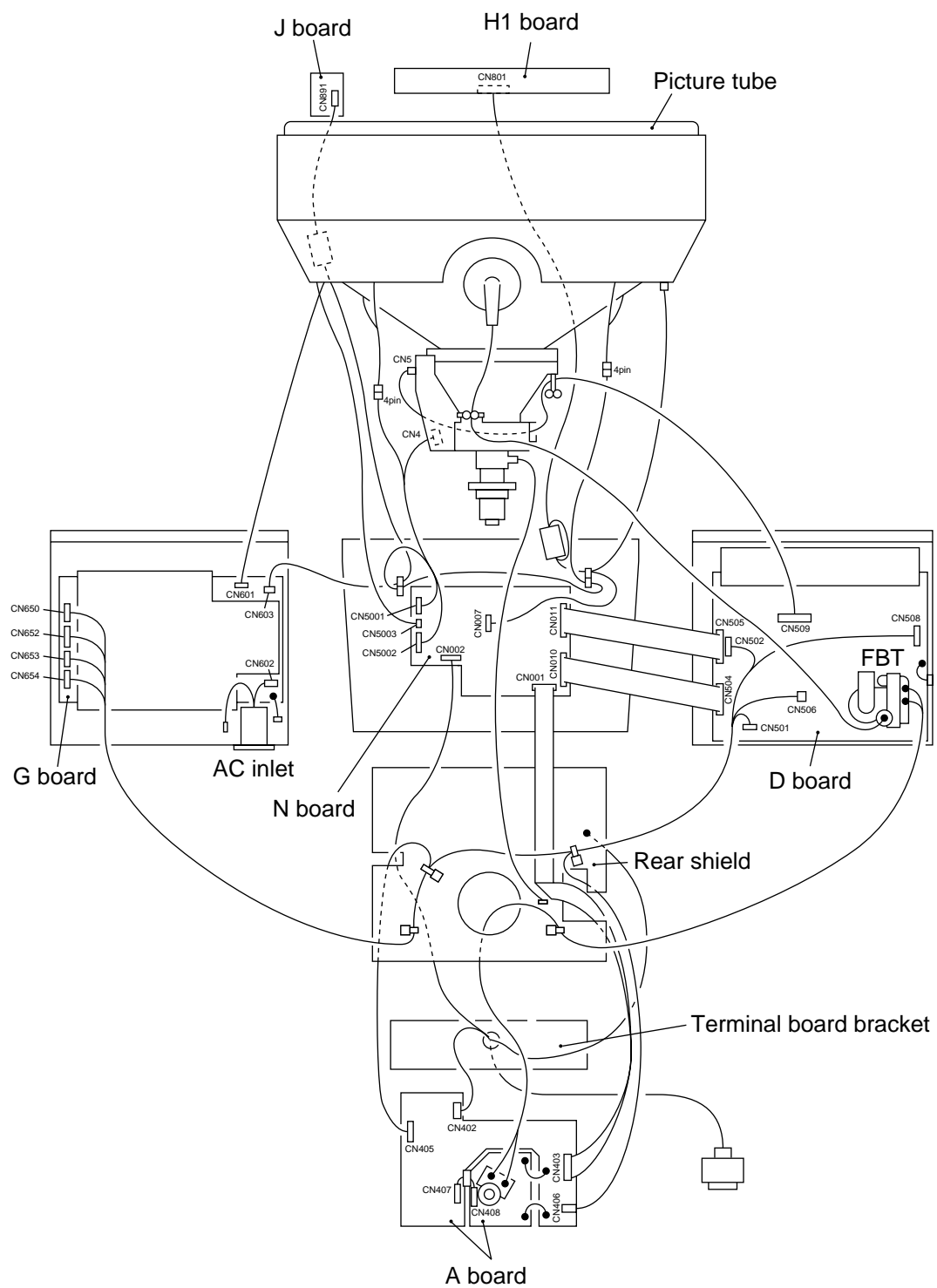

SAFETY RELATED ADJUSTMENT

When replacing or repairing the shown below table, the following operational checks must be performed as a safety precaution against X-rays emissions from the unit.

	Part Replaced (☒)
HV ADJ	RV901

	Part Replaced (☑)
HV Regulator Circuit Check	D Board C920, IC901, R923, R924, R929, R945, RV901, T902(FBT) • Mounted D Board
HV Protector Circuit Check	D Board C922, C925, C926, D912, D914, D915, D921, Q907, Q908, R921, R922, R932, R937, R939, T902(FBT) • Mounted D Board
Beam Current Protector Circuit Check	D Board C910, C921, C933, D901, D902, D913, IC503, IC901, R901, R920, R928, R930, R931, R940, R941, T902(FBT) • Mounted D Board G Board IC652 • Mounted G Board N Board IC001, R031, R032 • Mounted N Board

* Confirm one minute after turning on the power.

a) HV Regulator Circuit Check

- 1) Enter black crosshatch signal (black on white background), and check that high voltage is in the specified range.
[Specification]: 27.00 ±0.10 kV
- 2) Check that the voltage of D912 cathode on the D board is 27.0 V or more.

b) HV Protector Circuit Check

- 1) Enter black crosshatch signal (black on white background).
- 2) Apply the specified voltage to the D912 cathode on the D board, and check that high voltage is 0.1 kV or less.
[Specification]: 31.90 +0.00/-0.05 V

c) Beam Current Protector Circuit Check

(1st Protector): D Board

- 1) Apply 4.5 V DC to CN504 ⑩ pin on the D board, and check high voltage value.
- 2) Connect constant current source to a section between T902 (FBT) ⑪ pin and ⑫ pin (GND) on the D board, and check that high voltage checked in 1) lowers by 1.50 kV or more when the specified current flows to the ⑪ pin.
[Specification]: 2.00 +0.00/-0.01 mA

d) Beam Current Protector Circuit Check

(2nd Protector): D Board

- 1) Connect constant current source to a section between T902 (FBT) ⑪ pin and ⑫ pin (GND) on the D board, and check that the voltage of CN504 ⑩ pin becomes 0 V or less when the specified current flows to the ⑪ pin.
[Specification]: 1.70 +0.00/-0.01 mA

e) Beam Current Protector Circuit Check

: G Board

- 1) Apply 264 V AC.
- 2) Enter about 5 V to CN650 ④ pin on the G board, and check that the output voltage of CN653 ② pin is about 15 V.
- 3) Enter about 0±0.2 V to CN654 ④ pin, and check that the output voltage of CN653 ② pin becomes 1.0 V or less.

f) Beam Current Protector Circuit Check

: N Board

- 1) Check that the protector operates, when the voltage of CN010 ⑩ pin on the N board is lowered to 0 V or less (for more than 2 seconds).

SECTION 4 ADJUSTMENTS

Note: Hand degauss must be used on stand-by or power-off condition.

This model has an automatic earth magnetism correction function by using an earth magnetism sensor and a LCC coil. When using a hand degauss while monitor (LCC coil) is being operated, it sometimes gets magnetized, and the system may not work properly as a result.

• Landing Rough Adjustment

1. Enter the full white signal. (or the full black dots signal).
2. Adjust the contrast to the maximum.
3. Make the screen monogreen.

Note: Off the outputs from R ch and B ch of SG.

4. Reverse the DY, and adjust coarsely the purity magnet so that a green raster positions in the center of screen.
5. Adjust the tilt of DY, and fix lightly with a clamp.

Note: "TILT" = "128".

• Landing Fine Adjustment

1. Put the set inside the Helmholtz coil. ("LCC SW" = "12")
2. Input the single green signal and set the "CONTRAST" = "255".

Note: After the W/B adjustment with 9300K, measure an average of ΣI_k when a full white signal is entered in the CONT MAX/BRT CENT status. Then make adjustment so that the specified screen can be attained after aging for 2 hours with I_k equivalent to 30% of the average value.

3. Demagnetize the metal part of the chassis with the hand degausser and coil degausser, and the CRT surface with the hand degausser.

Input AC 230V to AC IN, turn on and off the power to perform auto degaussing. (Perform auto degaussing by setting "FUNCTION SW"=1. Return to the original value after use.)

Demagnetize the CRT surface with the hand degausser again.

Note:

- (1) Hand degauss must be used on stand-by or power-off condition.
This model has an automatic earth magnetism correction function by using an earth magnetism sensor and a LCC coil. When using a hand degauss while monitor (LCC coil) is being operated, it sometimes gets magnetized, and the system may not work properly as a result.
- (2) Adjust in a non-magnetic field.
- (3) If adjusting in a magnetic fields, add the shift from the non-magnetic field in your estimation.
4. Attach the wobbling coil to the designated part of the CRT neck.
5. Attach the sensor of the landing adjustment unit on the CRT surface.
6. Adjust the DY position and purity, and the DY tilt, and landing of the center and 4 corners with the landing checker.
After adjustment, set "LCC SW" to "13".

- Write terrestrial magnetism sensor reading VX and VY to "LCC VX" and "LCC VY" respectively. Adjust the landing by moving "LCC NS", "LCC LT", "LCC LB", "LCC RT" and "LCC RB". However, the register adjustment must be limited within the following range.

"LCC NS" 128 ± 15

"LCC LT", "LCC LB", "LCC RT", "LCC RB" 128 ± 40

Save the service data.

<Specifications>

Adjust so that the green is within the specification given right.

4 corner adjust target : within ± 1

_____ (μm)		
0 ± 3	0 ± 7.5	0 ± 3
0 ± 3	0 ± 7.5	0 ± 3
0 ± 3	0 ± 7.5	0 ± 3

The red and blue must be within the specification given right with respect to the green.

_____ (μm)		
± 6	± 6	± 6
± 6	± 6	± 6
± 6	± 6	± 6

A difference between red and blue must be within the specification given right.

_____ (μm)		
10	10	10
10	7	10
10	10	10

* Adjustment and measurement should be made at the points one inch inside the fluorescent screen.

7. Tighten DY screw
Note: Torque $22 \pm 2 \text{ kg}\cdot\text{cm}$ ($2.2 \pm 0.2 \text{ Nm}$) autodegauss it.
8. For the up/down swing, swing the DY and insert a wedge so that the up and down pins are equal at the top and bottom. Adjust the H.TRP VR of DY so that the horizontal trapezoid is equal at the left and right. Insert the wedge firmly so that the DY does not shake.
9. Check the landing of each corner, and if it does not satisfy the specification, adjust the landing of four corners using "LCC LT", "LCC LB", "LCC RT" and "LCC RB".
However, the register adjustment must be limited within the following range.
"LCC NS" 128 ± 15
"LCC LT", "LCC LB", "LCC RT", "LCC RB" 128 ± 40
After adjustment, save the service data.
10. Remove the sensor and wobbling coil.
11. Switch the signal to R.G.B., and check that each color is pure.
12. Check that the DY is not tilting, and fix the purity Mg with a white pen. Fix wedges with RTV.

CPD-E500/E500E

Connect the communication cable of the computer to the connector located on the D board. Run the service software and then follow the instruction.

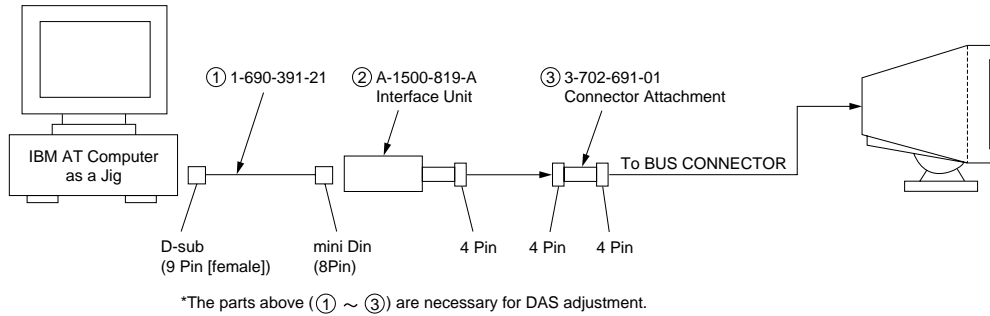

• Convergence Rough Adjustment

- Receive an image of the white crosshatch signals (white lines on black).
- Place the protrusions of the 6-fold poles magnet attached to the CRT neck upon each other.
- Make rough adjustment of the H and V direction convergence by using 4-fold poles magnet.

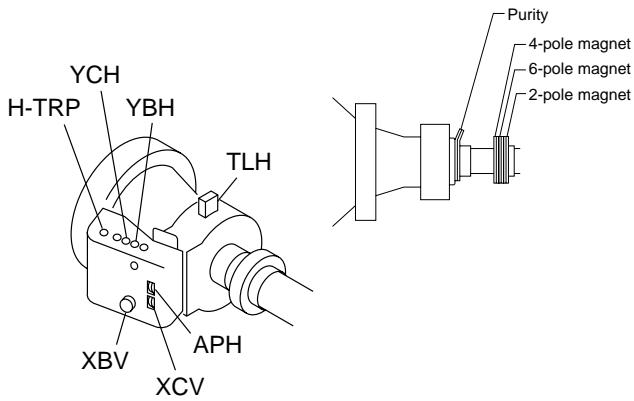

* Set so that the protruding parts of the 2 magnet rings agree with each other.

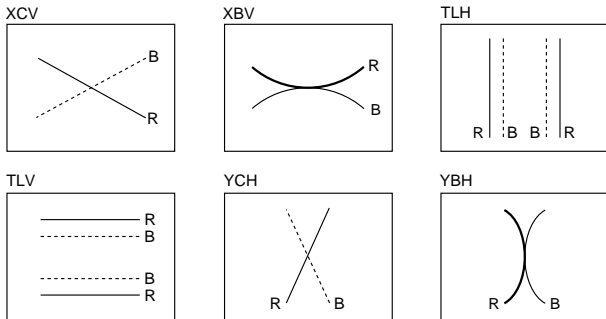

• Convergence Specification

	fH	60kHz ≤	60kHz >
	A	0.20 mm	0.24 mm
	B	0.24 mm	0.28 mm

• White Balance Adjustment Specification

- 9300K
 $x=0.283 \pm 0.005$
 $y=0.298 \pm 0.005$
 (All White)
- 6500K
 $x=0.313 \pm 0.005$
 $y=0.329 \pm 0.005$
 (All White)
- 5000K
 $x=0.346 \pm 0.005$
 $y=0.359 \pm 0.005$
 (All White)

• Vertical and Horizontal Position and Size Specification

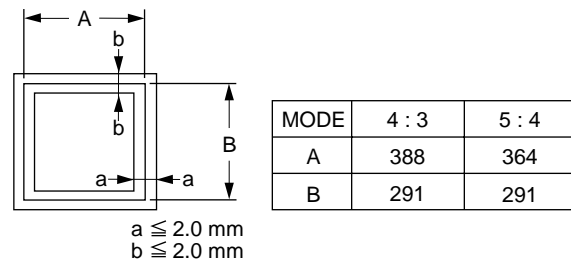

• Focus adjustment

Adjust the focus volume 1 and 2 for the optimum focus.

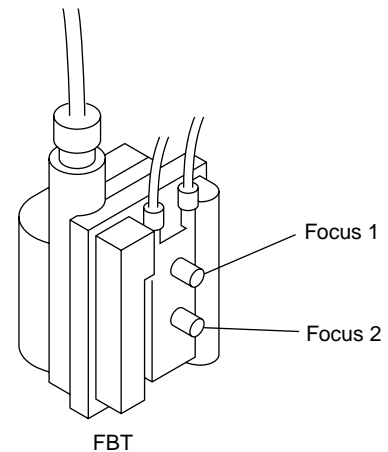

SECTION 5 DIAGRAMS

5-1. BLOCK DIAGRAMS

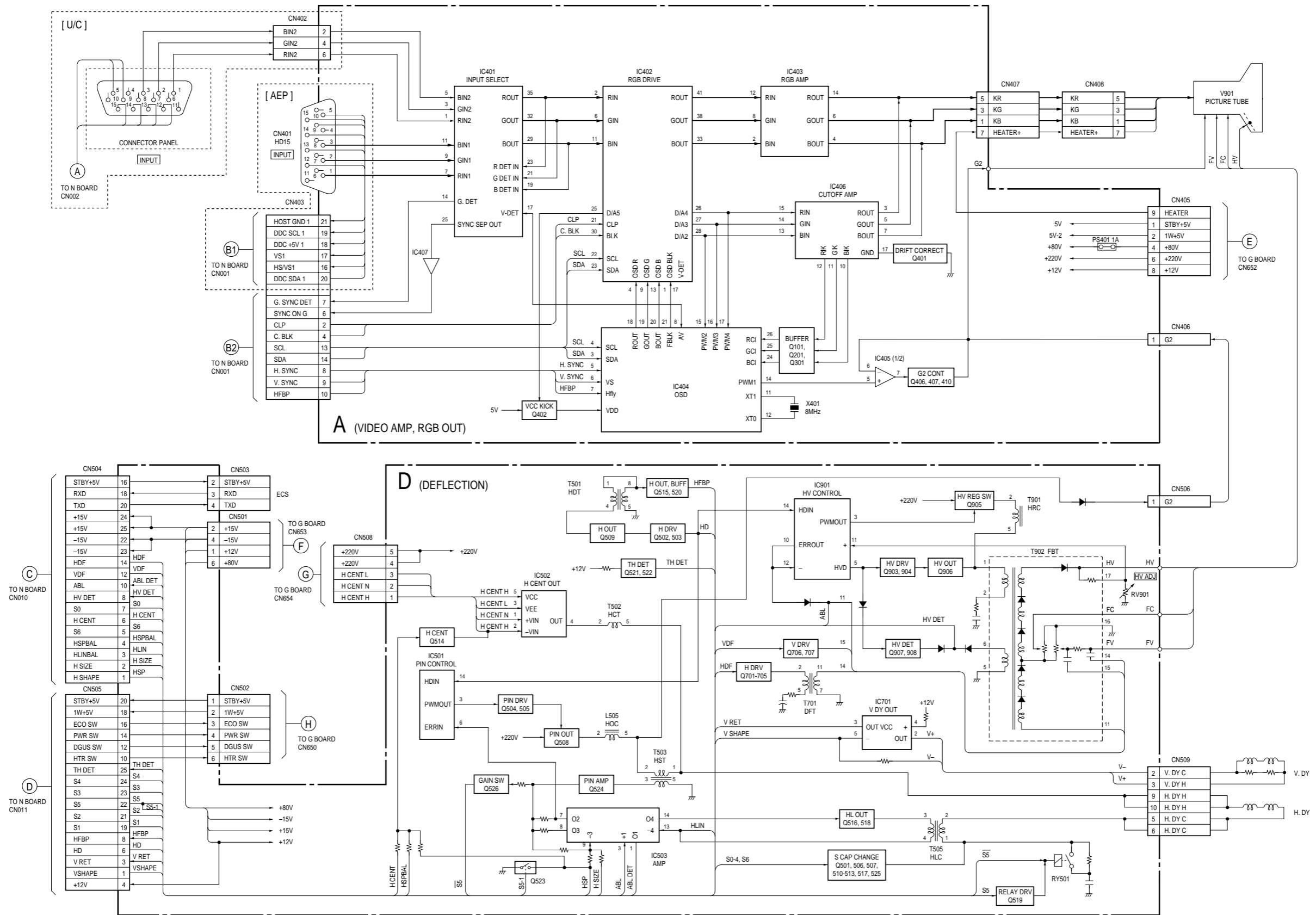

B-SS325-U/C-BD1-EP905

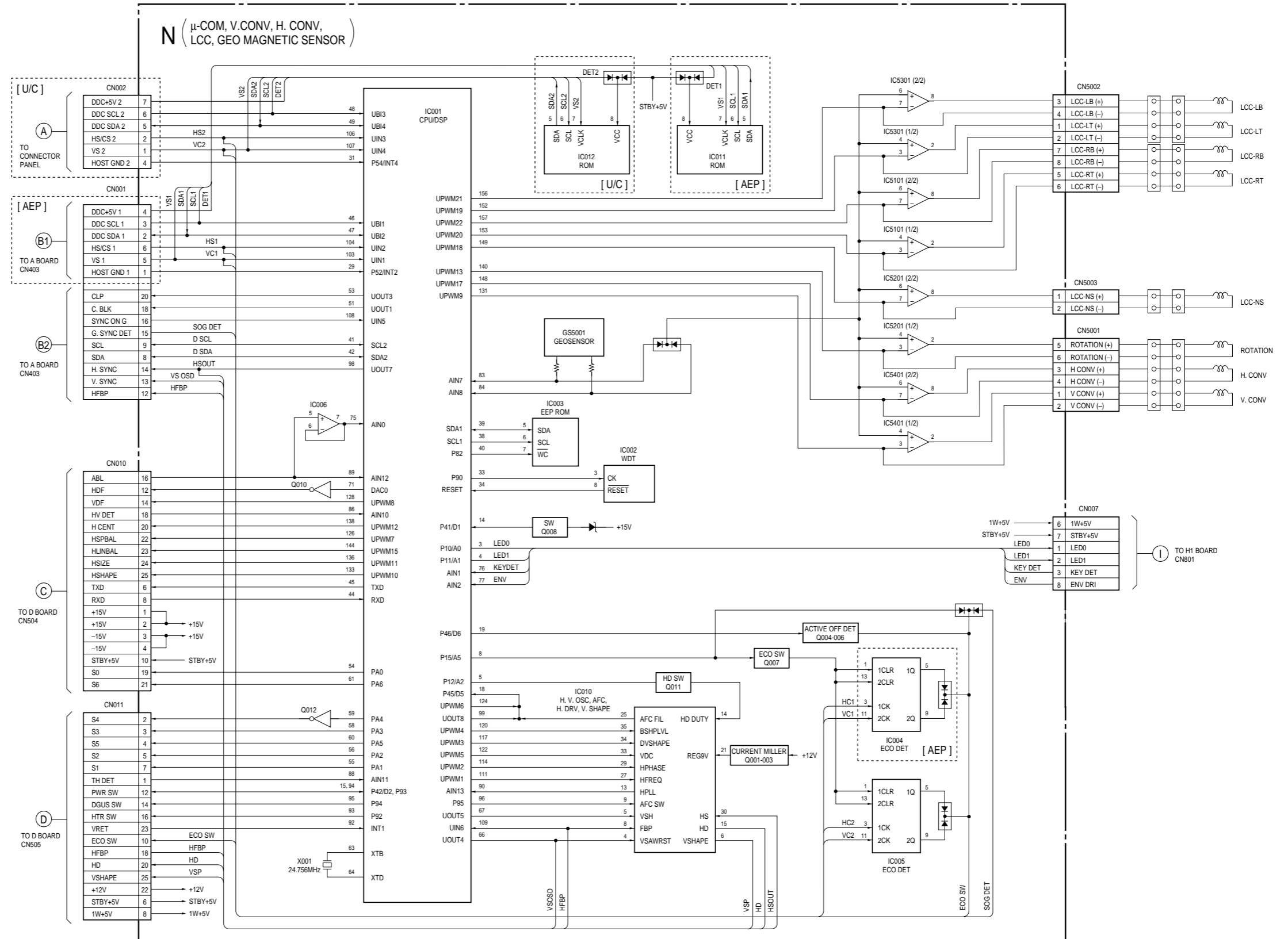

B-SS3525-U/C-BD2-EP505

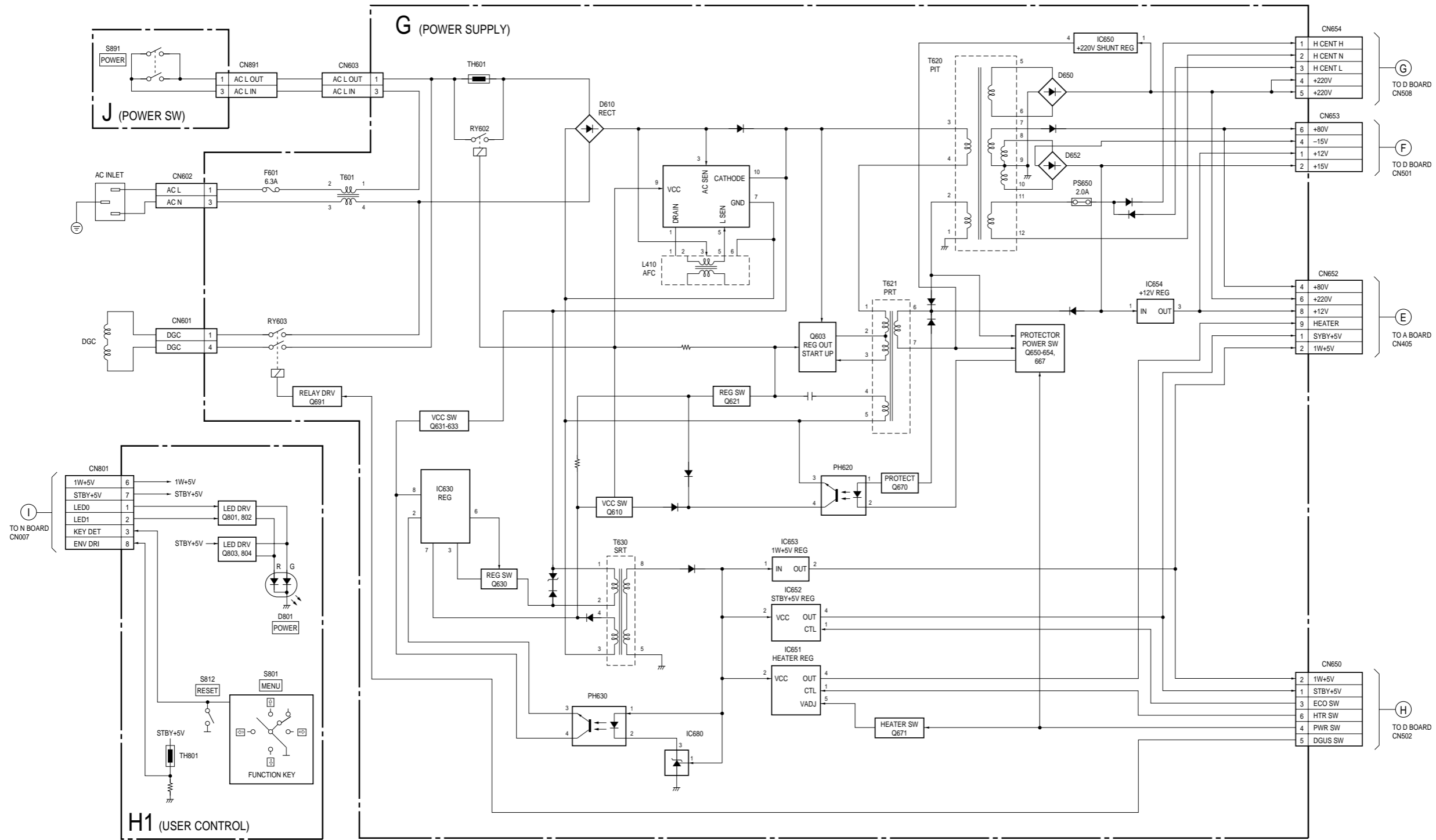

B-SS3525 <U/C> -BD3-EP505

5-2. FRAME SCHEMATIC DIAGRAM

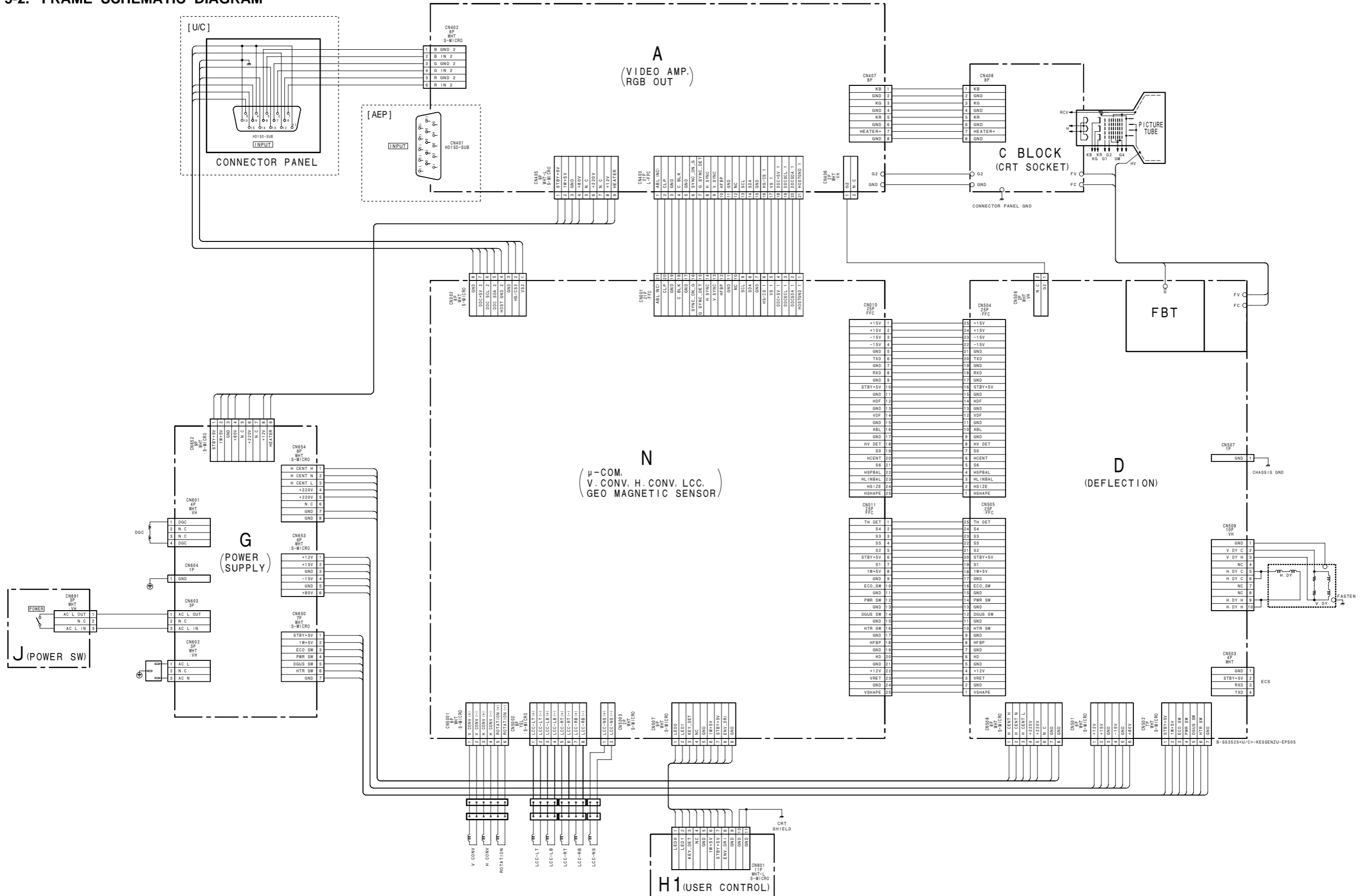

5-3. CIRCUIT BOARDS LOCATION

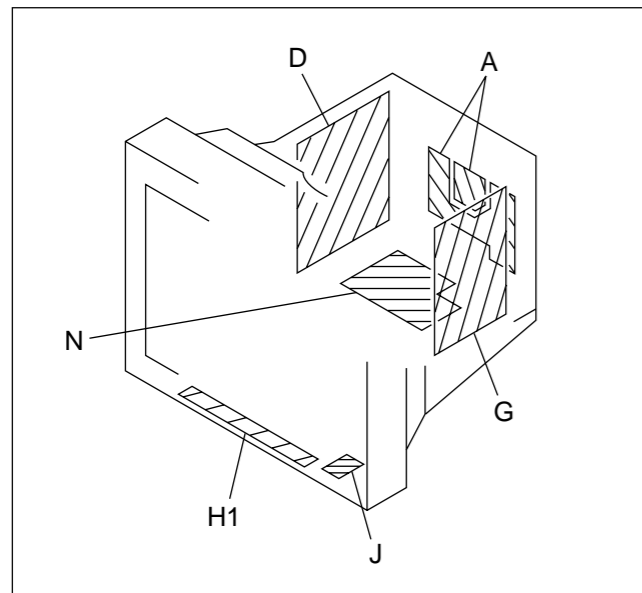

5-4. SCHEMATIC DIAGRAMS AND PRINTED WIRING BOARDS

Note:

- All capacitors are in μF unless otherwise noted. (pF: μpF) Capacitors without voltage indication are all 50 V.
- Indication of resistance, which does not have one for rating electrical power, is as follows.

Pitch: 5 mm
Rating electrical power 1/4 W (CHIP : 1/10 W)

- All resistors are in ohms.
- : nonflammable resistor.
- : fusible resistor.
- Δ : internal component.
- : panel designation, and adjustment for repair.
- All variable and adjustable resistors have characteristic curve B, unless otherwise noted.
- \perp : earth-ground.
- : earth-chassis.
- The components identified by in this basic schematic diagram have been carefully factory-selected for each set in order to satisfy regulations regarding X-ray radiation. Should replacement be required, replace only with the value originally used.
- When replacing components identified by , make the necessary adjustments indicated. (See page 3-1)
- When replacing the part in below table, be sure to perform the related adjustment.

Note: The components identified by shading and mark ! are critical for safety. Replace only with part number specified.

Note: Les composants identifiés par un tramé et une marque ! sont critiques pour la sécurité. Ne les remplacer que par une pièce portant le numéro spécifié.

- All voltages are in V.
- Readings are taken with a 10 M digital multimeter.
- Readings are taken with a color-bar signal input.
- Voltage variations may be noted due to normal production tolerances.
- * : Can not be measured.
- Circled numbers are waveform references.
- : B + bus.
- : B - bus.

- Divided circuit diagram
One sheet of N board circuit diagram is divided into three sheets, each having the code N-Ⓐ to N-Ⓒ. For example, the destination (ab1) on the code N-Ⓐ sheet is connected to (ab1) on the N-Ⓑ sheet.

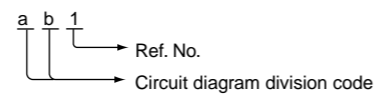

	Part Replaced ()
HV ADJ	RV901

	Part Replaced ()
HV Regulator Circuit Check	D Board C920, IC901, R923, R924, R929, R945, RV901, T902(FBT) • Mounted D Board
HV Protector Circuit Check	D Board C922, C925, C926, D912, D914, D915, D921, Q907, Q908, R921, R922, R932, R937, R939, T902(FBT) • Mounted D Board
Beam Current Protector Circuit Check	D Board C910, C921, C933, D901, D902, D913, IC503, IC901, R901, R920, R928, R930, R931, R940, R941, T902(FBT) • Mounted D Board G Board IC652 • Mounted G Board N Board IC001, R031, R032 • Mounted N Board

Terminal name of semiconductors in silk screen printed circuit (※)

	Device	Printed symbol	Terminal name	Circuit
①	Transistor		Collector Base Emitter	
②	Transistor		Collector Base Emitter	
③	Diode		Cathode Anode	
④	Diode		Cathode Anode (NC)	
⑤	Diode		Cathode Anode (NC)	
⑥	Diode		Common Anode Cathode	
⑦	Diode		Common Anode Cathode	
⑧	Diode		Common Anode Anode	
⑨	Diode		Common Anode Anode	
⑩	Diode		Common Cathode Cathode	
⑪	Diode		Common Cathode Cathode	
⑫	Diode		Anode Cathode Anode Cathode	
⑬	Transistor (FET)		Drain Source Gate	
⑭	Transistor (FET)		Drain Source Gate	
⑮	Transistor (FET)		Source Drain Gate	
⑯	Transistor		Emitter Collector Base	
—	Discrete semiconductor			

(Chip semiconductors that are not actually used are included.)

Ver.1.6

(1) Schematic Diagram of A Board

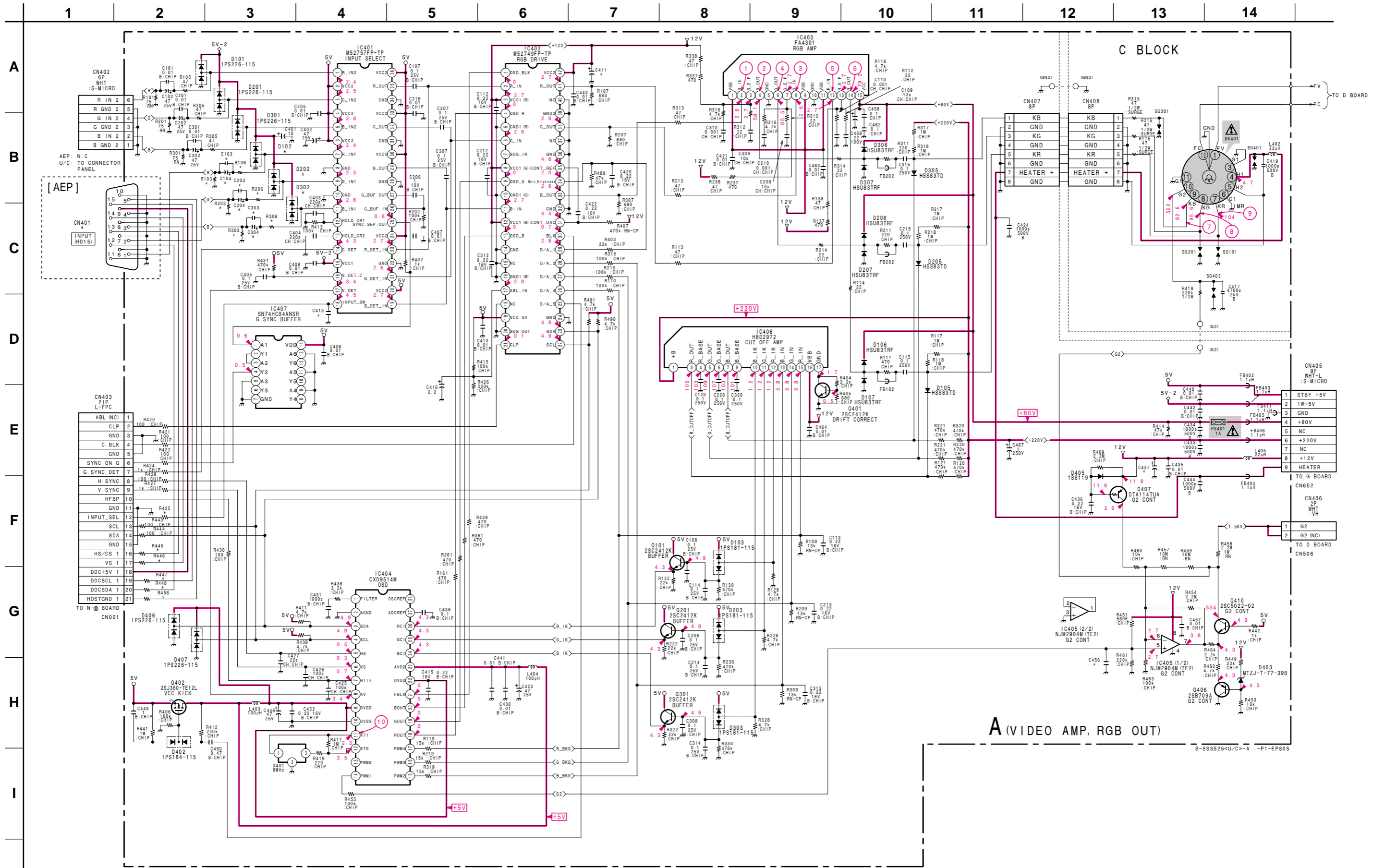

Schematic diagram

A board →

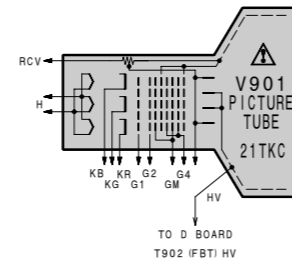
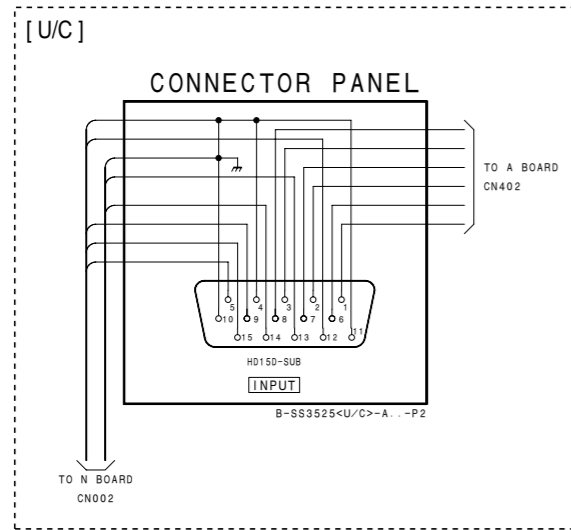

• A BOARD IC401 M52757FP

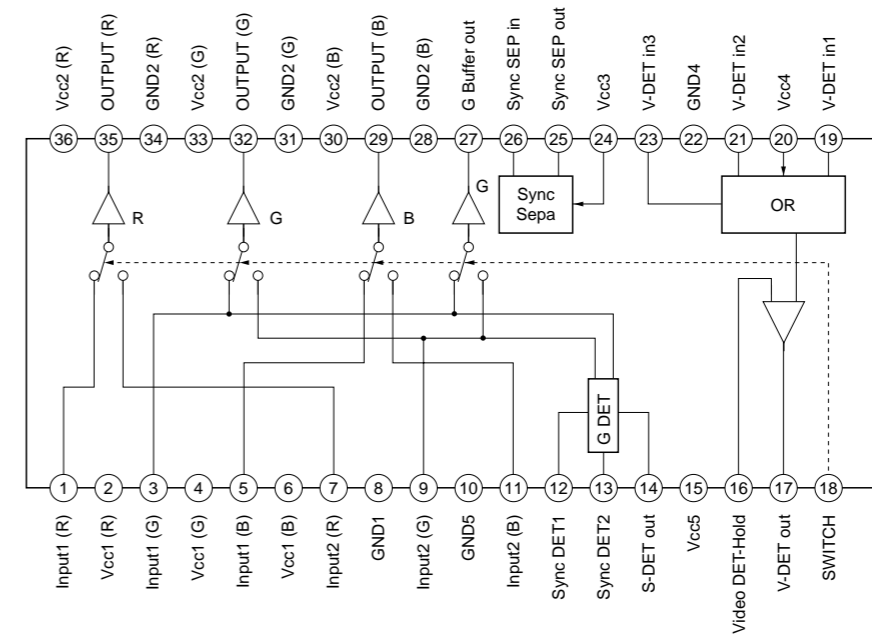

• A BOARD * MARK LIST

Ref. No.	[AEP]	[U/C]
C103	0.01/ B:CHIP	-
C104	47/ 25V	-
C203	0.01/ B:CHIP	-
C204	47/ 25V	-
C303	0.01/ B:CHIP	-
C304	47/ 25V	-
C411	220/ 16V	47/ 25V
C413	0.01/ B:CHIP	100/ :CHIP
C437	470/ :16V	220/ 16V
C456	0.22/ 16V/ B:CHIP	-
CN401	HD15D-SUB	-
D102	1PS226-115	-
D202	1PS226-115	-
D302	1PS226-115	-
R103	75/ :RN	-
R106	47/ :CHIP	-
R203	75/ :RN	-
R206	47/ :CHIP	-
R303	75/ :RN	-
R306	47/ :CHIP	-
R425	1K/ :CHIP	-
R445	100/ :CHIP	-
R446	100/ :CHIP	-
R447	47/ :CHIP	-
R448	47/ :CHIP	-
R456	100/ :CHIP	-

- : Not used

• A BOARD WAVEFORMS

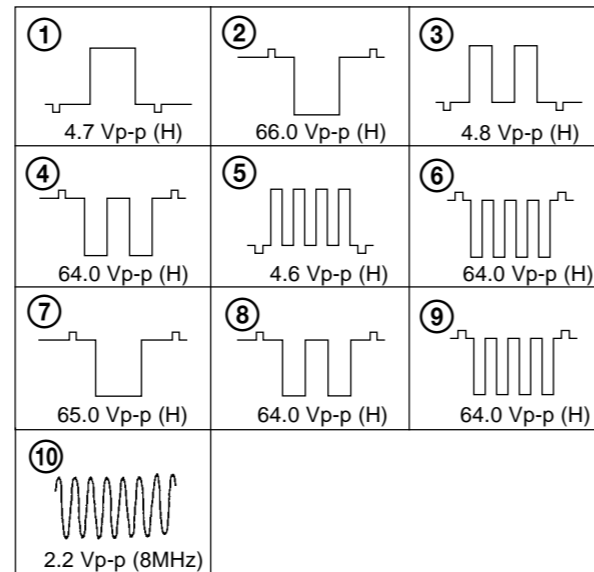

• A BOARD IC402 M52749FP

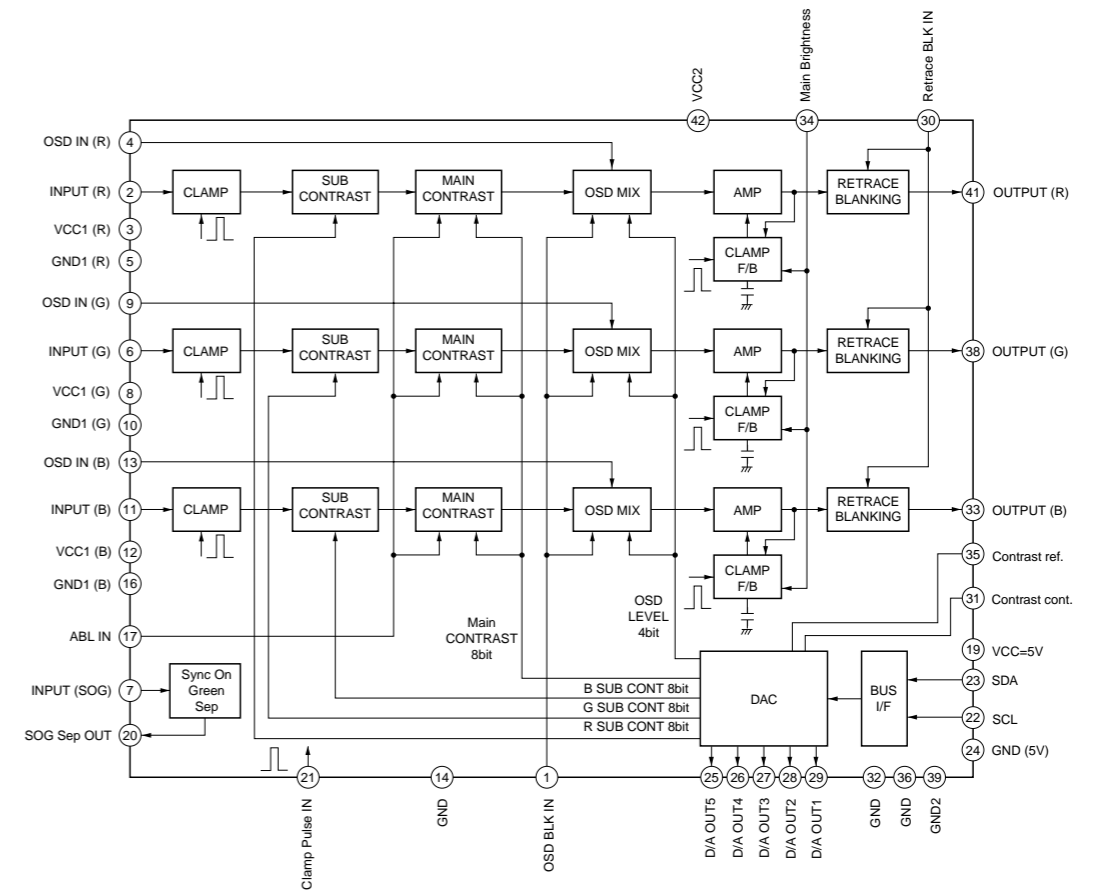

— A BOARD (Conductor Side) —

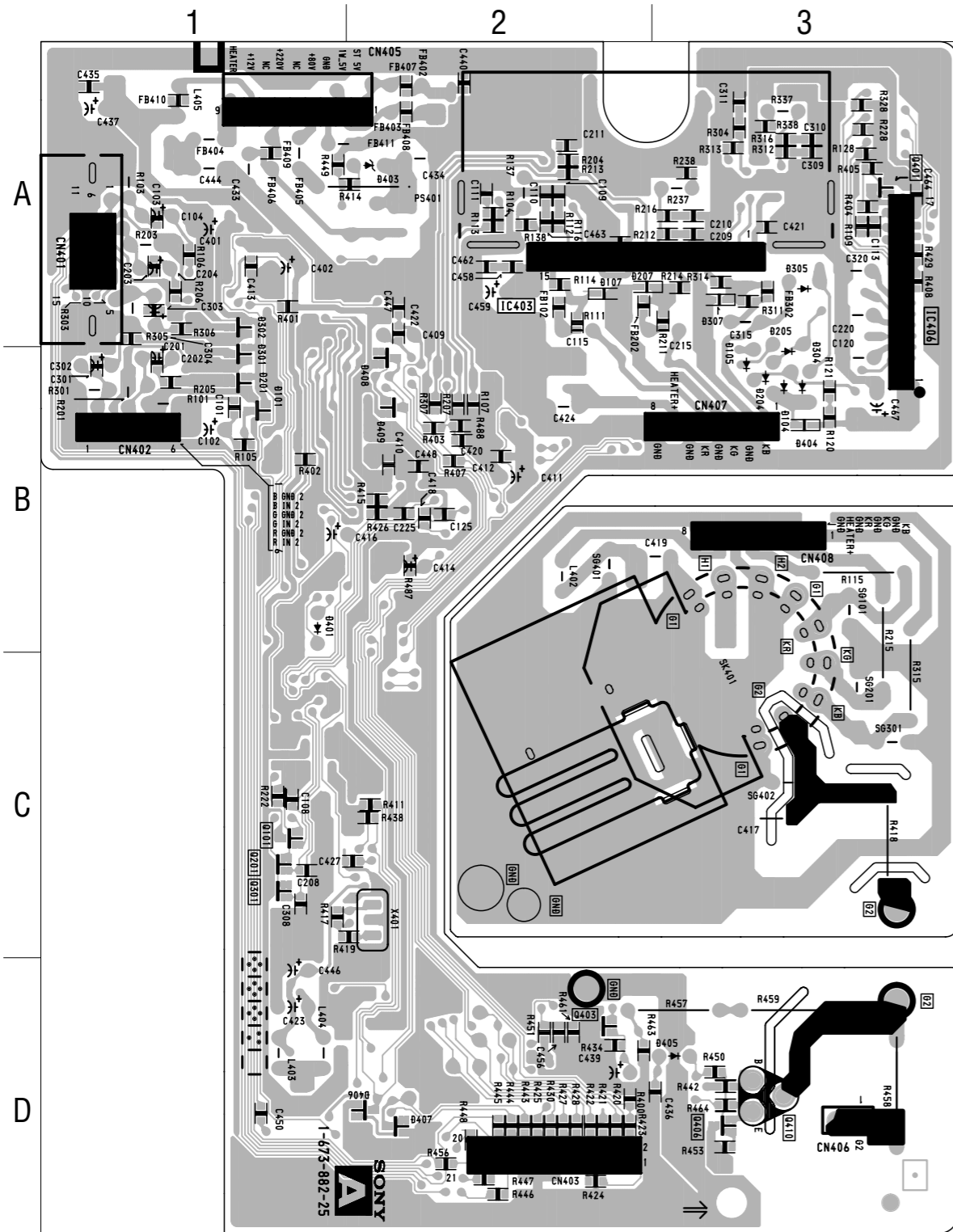

• A BOARD SEMICONDUCTOR LOCATION

IC		(Conductor Side)	(Component Side)
IC401		B-3	B-3
IC402		B-2	B-2
IC403		A-2	A-2
IC404		C-3	C-3
IC405		D-2	D-2
IC406		A-1	A-1
IC407		D-2	D-2

TRANSISTOR		(Conductor Side)	(Component Side)	*
Q101		C-1		①
Q201		C-1		①
Q301		C-1		①
Q401		A-3		①
Q402			D-3	②
Q406		D-3		①
Q407		D-2		②
Q410		D-3	D-1	①

DIODE		(Conductor Side)	(Component Side)	*
D101		B-1		⑧
D102			A-3	⑦
D103			A-1	⑩
D105		B-3	B-1	③
D106		A-2	A-2	④
D107		A-2		⑨
D201		B-1		⑥
D202			A-3	⑦
D203			A-1	⑩
D205		B-3	A-1	③
D206		A-2	A-1	④
D207		A-2		⑨
D301		B-1		⑥
D302		A-1		⑧
D303			A-1	⑩
D305		A-3	A-1	③
D306		A-2	A-1	④
D307		A-3		⑨
D402			D-3	②
D403		A-2	A-2	④
D405		D-3	D-1	①
D406		D-2		⑥
D407		D-2		⑥

CRYSTAL		(Conductor Side)	(Component Side)
X401		C-2	C-2

*: Refer to Terminal name of semiconductors in silk screen printed circuit (see page 5-10)

— A BOARD (Component Side) —

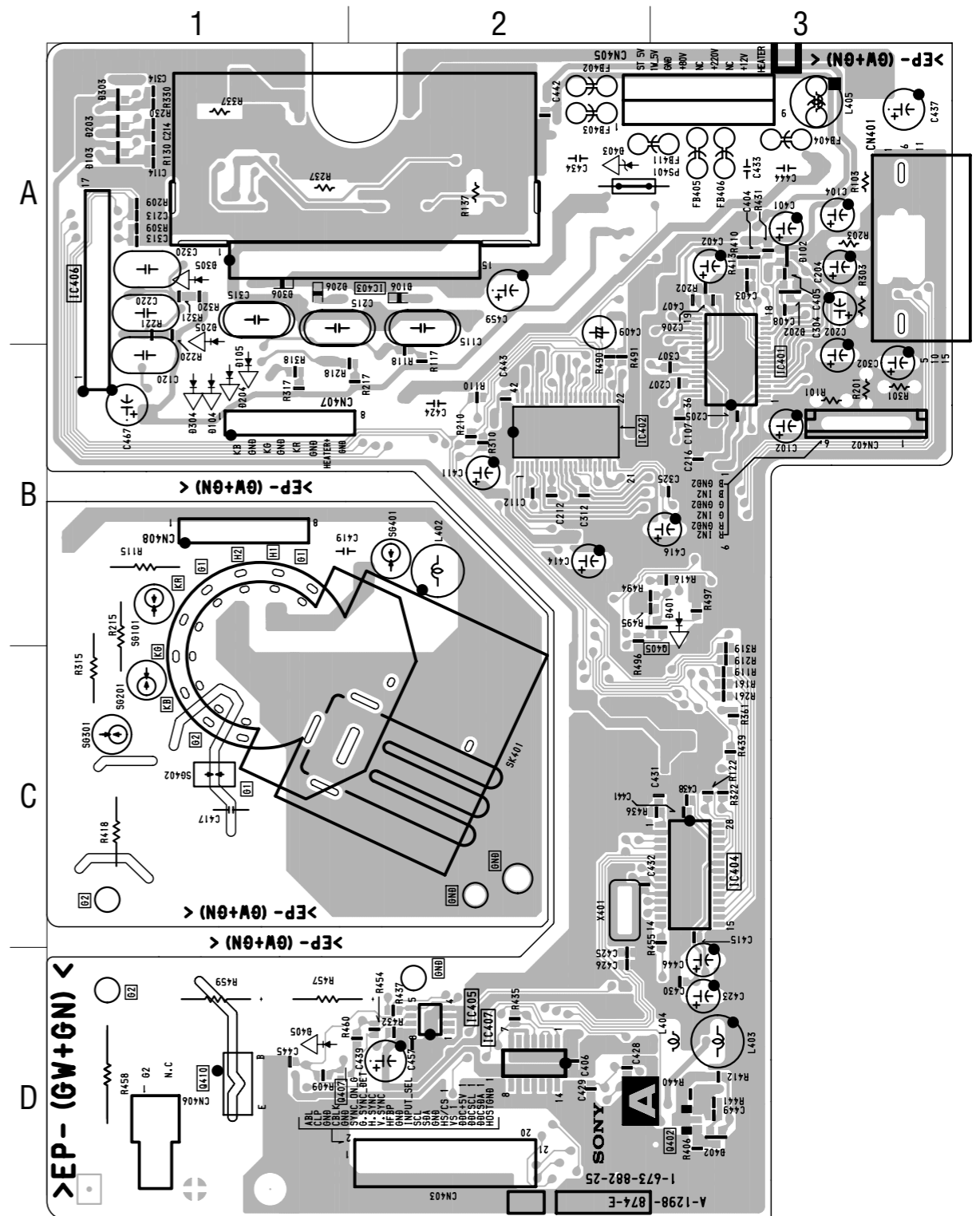

NOTE:
The circuit indicated as left contains high voltage of over 600 Vp-p. Care must be paid to prevent an electric shock in inspection or repairing.

(2) Schematic Diagrams of H1, J Boards

	1	2	3	4	5	6	7	8	9	10	11	12	13	14
--	---	---	---	---	---	---	---	---	---	----	----	----	----	----

A
B
C
D
E
F
G
H
I
J

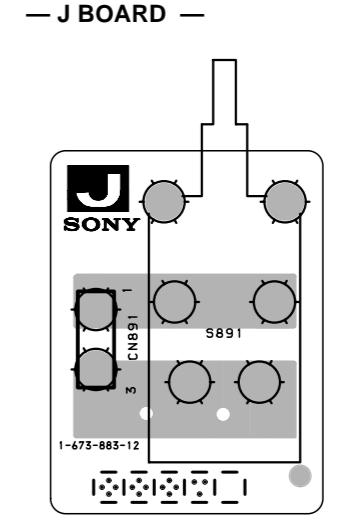
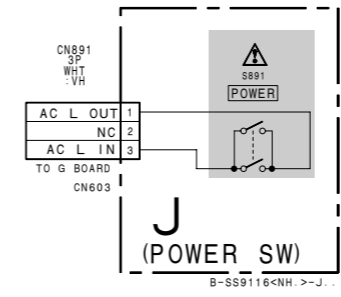
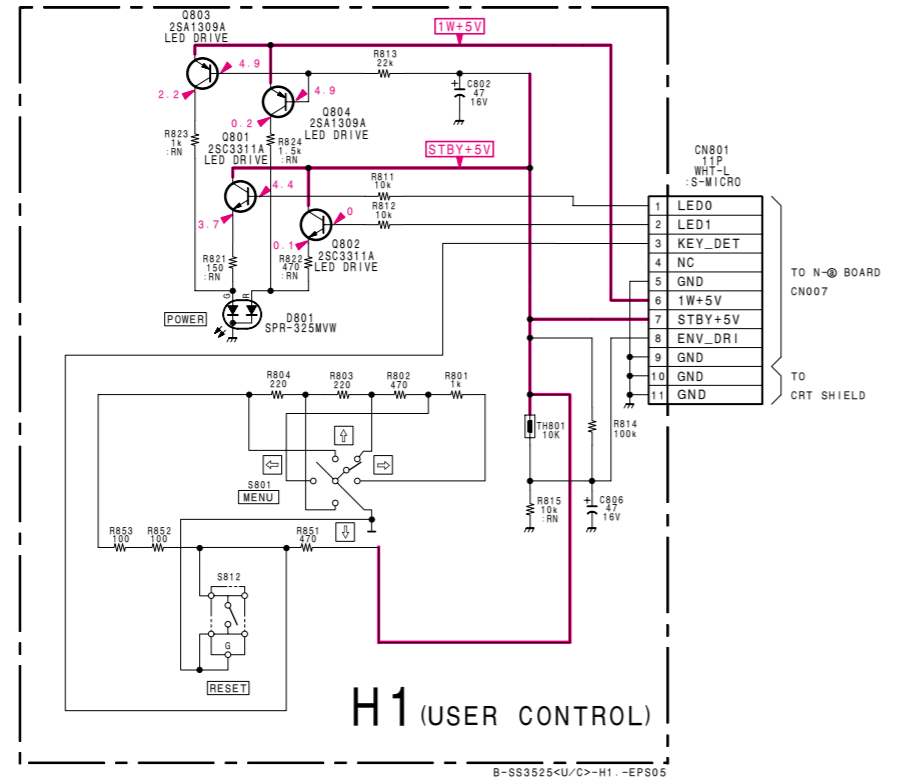

— H1 BOARD —

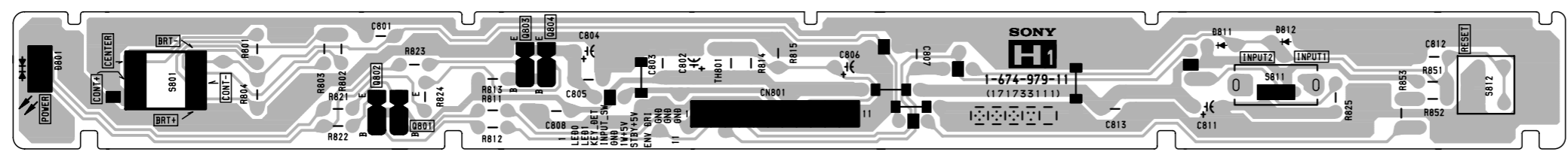

(3) Schematic Diagram of D Board

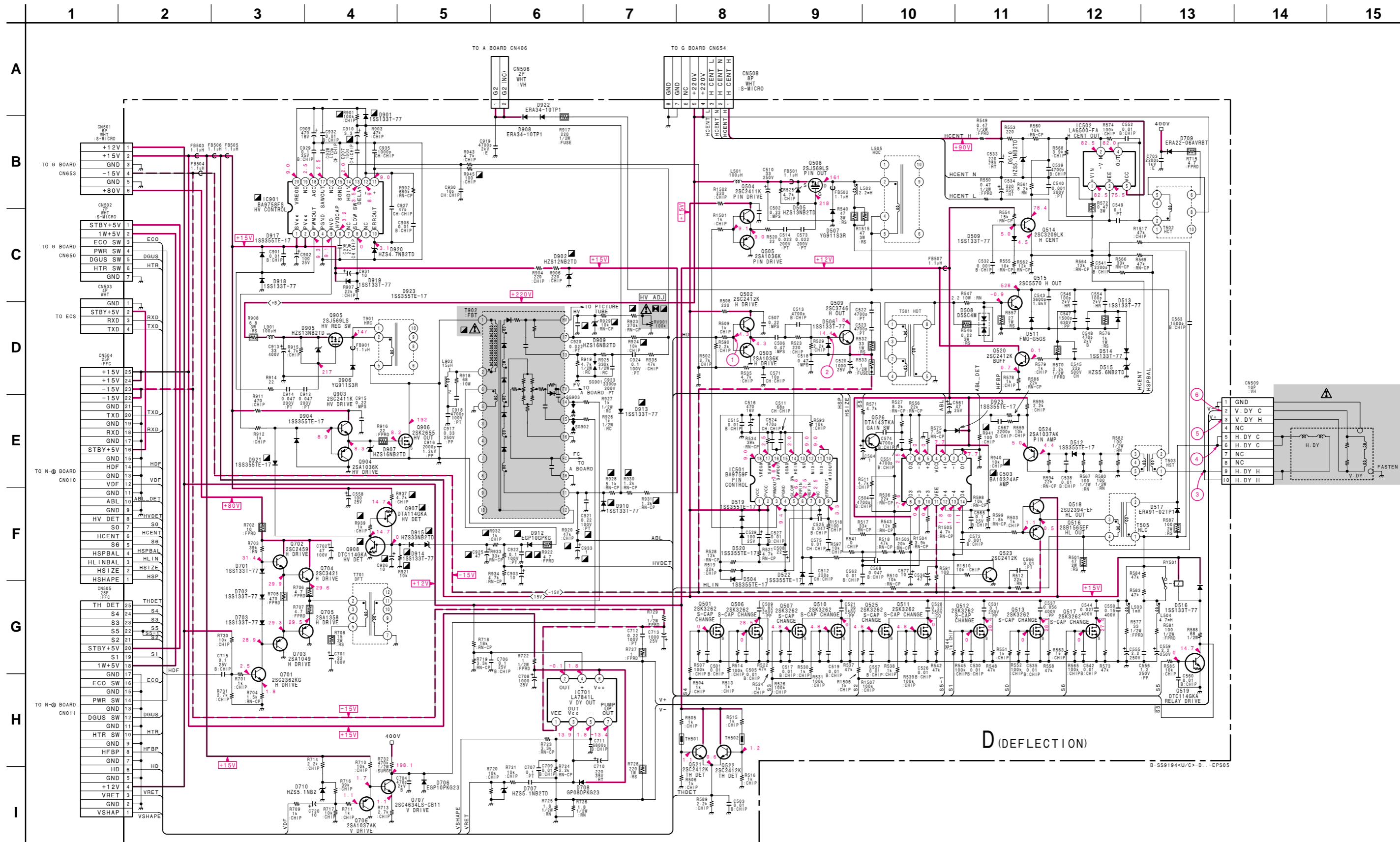

Schematic diagrams

← H1 J boards

Schematic diagram

D board →

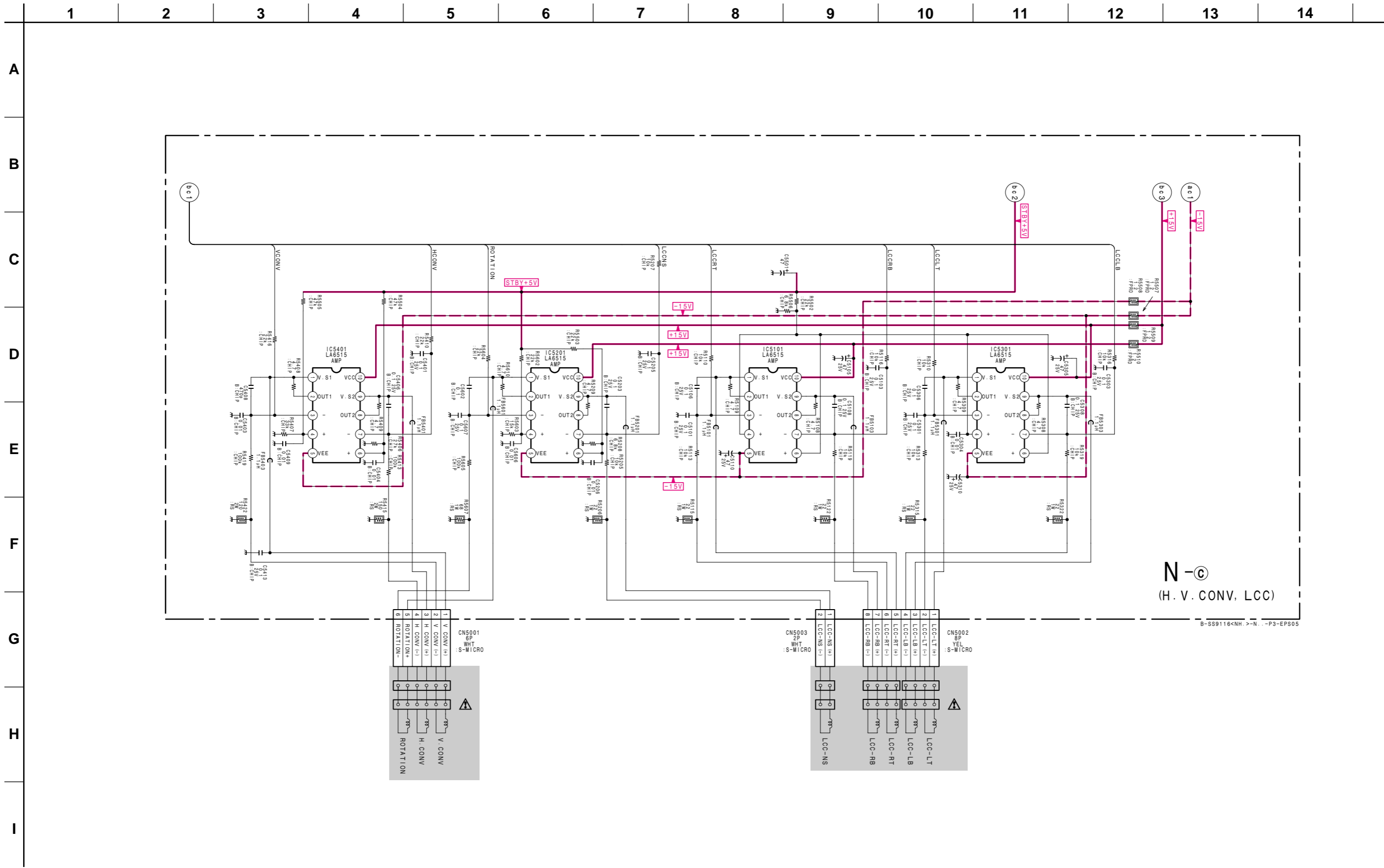

N-Ⓒ
(H.V. CONV, LCC)

B-SS9116<NH>->N...-P3-EPS05

Schematic diagram
← N-(b) board

Schematic diagram
N-Ⓒ board →

— N BOARD (Conductor Side) —

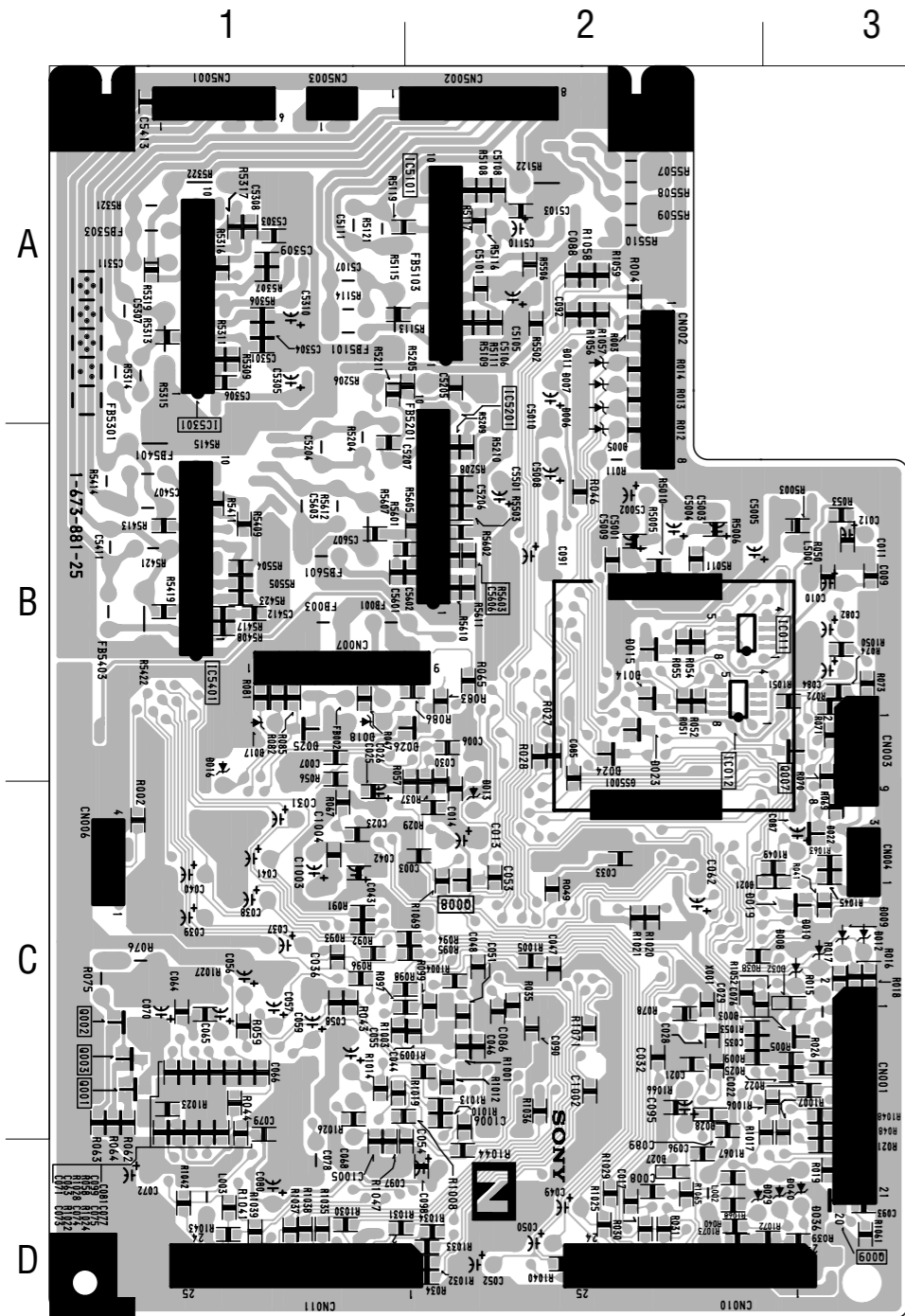

• N BOARD SEMICONDUCTOR LOCATION

IC		(Conductor Side)	(Component Side)
IC001	C-2		
IC002	C-2		
IC003	C-2		
IC004	B-2		
IC005	B-2		
IC006	D-1		
IC010	C-2		
IC011	B-2		
IC012	B-2		
IC5101	A-2	A-2	
IC5201	B-2	B-2	
IC5301	A-1	A-2	
IC5401	B-1	B-2	

TRANSISTOR		(Conductor Side)	(Component Side)	*
Q001	C-1			①
Q002	C-1			①
Q003	C-1			①
Q004	B-1			②
Q005	C-1			②
Q006	C-1			②
Q007	B-3			①
Q008	C-2			①
Q010	C-1			①
Q011	C-2			②
Q012	D-2			②

DIODE		(Conductor Side)	(Component Side)	*
D001	A-1			⑦
D002	A-1			⑦
D003	C-3			⑥
D004	C-1			⑦
D005	B-2			—
D006	A-2			—
D007	A-2			—
D008	C-3			—
D009	C-3			—
D010	C-3			—
D011	A-2			—
D012	C-3			—
D013	C-2			—
D014	B-2			⑧
D015	B-2			⑧
D016	B-1			B-2
D017	B-1			B-2
D018	B-1			B-2
D020	B-1			B-1
D021	C-3			⑧
D022	C-3			⑧
D023	B-2			⑧
D024	B-2			⑧
D025	B-1			⑧
D026	B-2			⑧
D027	D-2			⑧
D028	D-2			⑧
D029	D-3			D-1
D036	D-3			D-1
D038	C-1			⑧
D040	D-3			—

CRYSTAL		(Conductor Side)	(Component Side)
X001	C-2		C-1

*: Refer to Terminal name of semiconductor in silk screen printed circuit (see page 5-10)

— N BOARD (Component Side) —

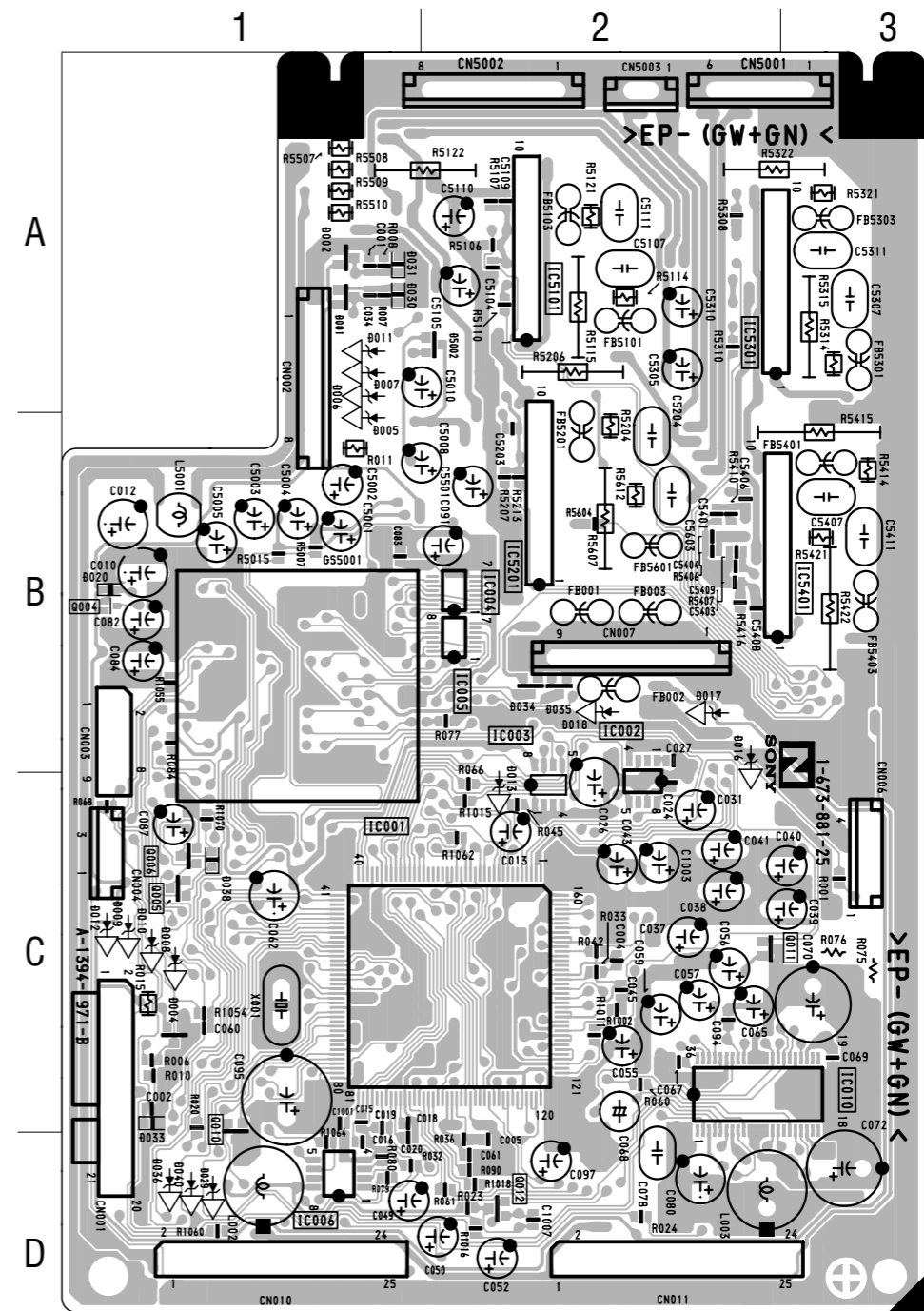

(5) Schematic Diagram of G Board

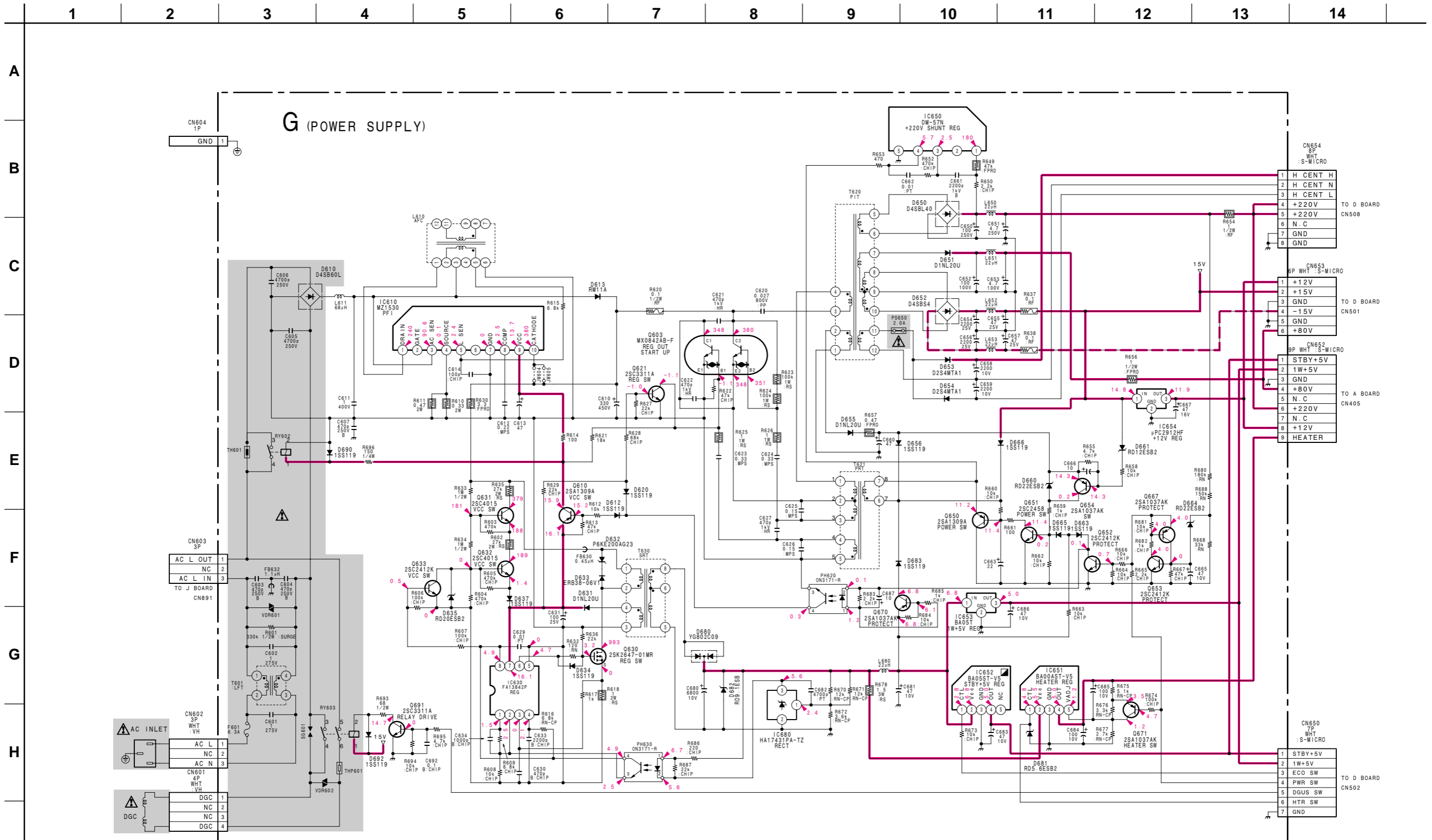

Schematic diagram
G board →

— G BOARD —

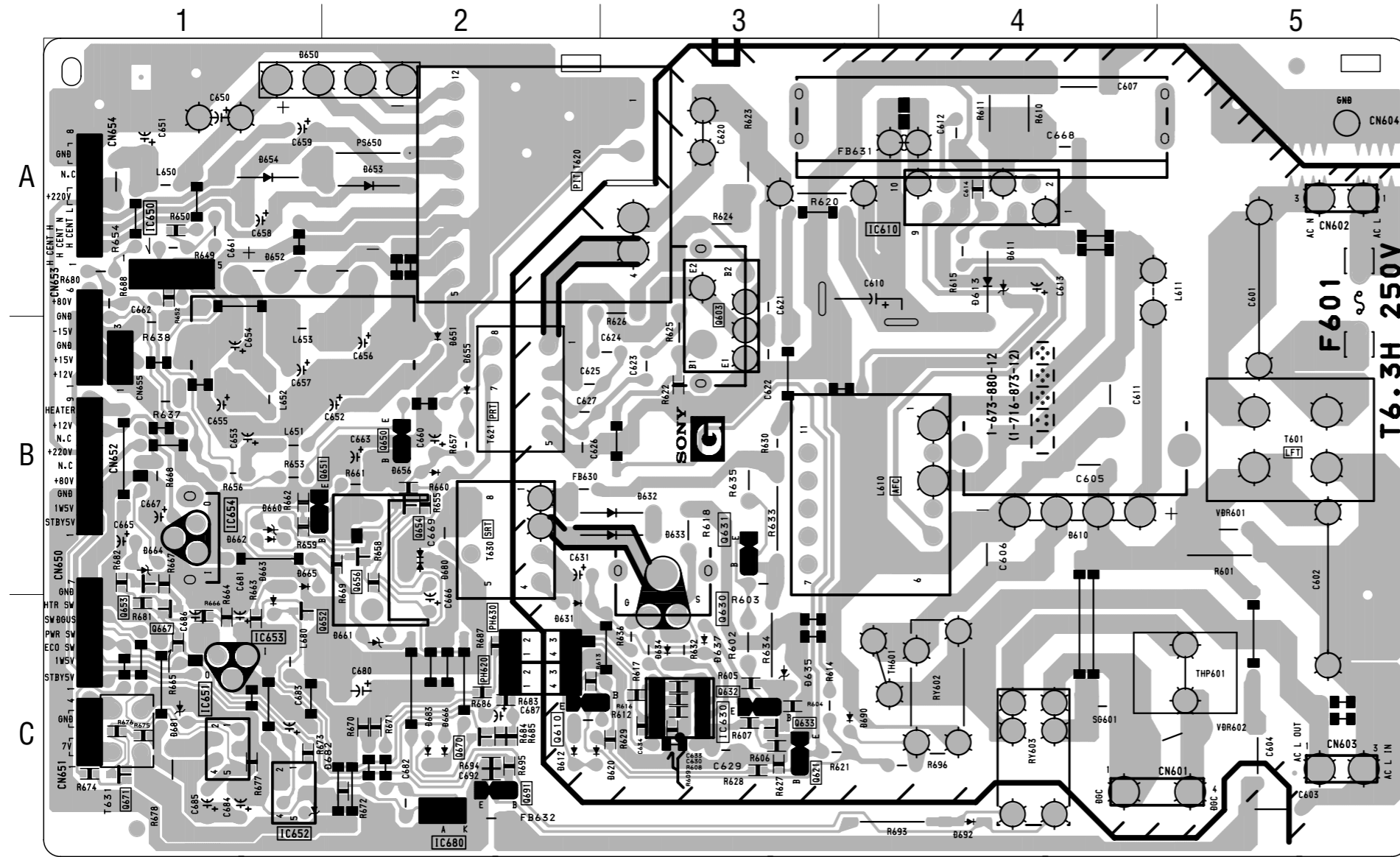

• G BOARD SEMICONDUCTOR LOCATION

IC		
IC610	A-4	
IC630	C-3	
IC650	A-1	
IC651	C-1	
IC652	C-1	
IC653	C-1	
IC654	B-1	
IC680	C-2	
TRANSISTOR		
Q603	A-3	*
Q610	C-2	-
Q621	C-3	-
Q630	C-3	-
Q631	B-3	-
Q632	C-3	-
Q633	C-3	⊕
Q650	B-2	-
Q651	B-1	-
Q652	C-1	⊕
Q653	B-1	⊕
Q654	B-2	⊕
Q667	C-1	⊕
Q670	C-2	⊕
Q671	C-1	⊕
Q691	C-2	-
DIODE		
D610	B-4	
D612	C-2	
D613	A-4	
D620	C-2	
D631	C-2	
D632	B-3	
D633	B-3	
D634	C-3	
D635	C-3	
D637	C-3	
D650	A-2	
D651	B-2	
D652	A-1	
D653	A-2	
D654	A-1	
D655	B-2	
D656	B-2	
D660	B-1	
D661	C-2	
D663	C-1	
D664	B-1	
D665	B-1	
D666	C-2	
D680	B-2	
D681	C-1	
D682	C-1	
D683	C-2	
D690	C-3	
D692	C-4	

*: Refer to Terminal name of semiconductors in silk screen printed circuit (see page 5-10)

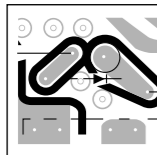
NOTE:

 The circuit indicated as left contains high voltage of over 600 Vp-p. Care must be paid to prevent an electric shock in inspection or repairing.

5-5. SEMICONDUCTORS

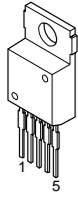
BA00AST-V5
BA05ST-V5
LA6500-FA

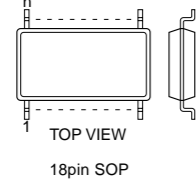

BA9759F-E2



18pin SOP

HA17431PA
HA17431PA-TZ

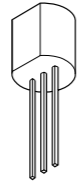

M52749FP-TP

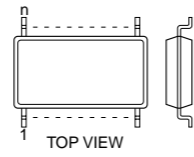

42pin SOP

MX0842AB-F

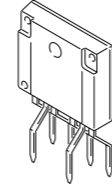

2SC4015TV2

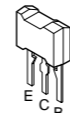

D1NL20U-TR
D2S4MF
D2S4MTA1

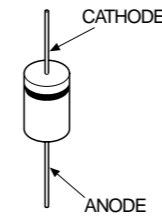

FMQ-G5GS

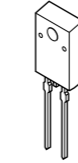

RD9.1ES-L2
RD9.1ES-T1B



1PS226-115

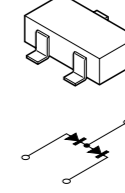

BA05T

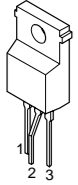

CXD8744Q-0007

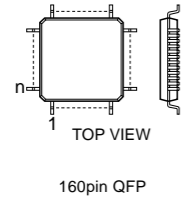

160pin QFP

H8D2972

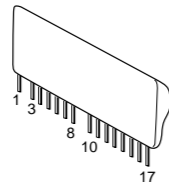

M52757FP-TP

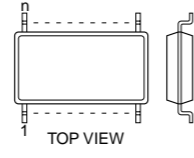

36pin SOP

2SA1049-GR
2SA1049TP-GR
2SC2458-YGR
2SC2458TP-YGR

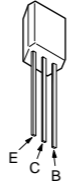

2SC5570(LBSONY)

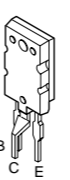

D4SB60L
D4SBL40
D4SBS4
D4SBS4-F

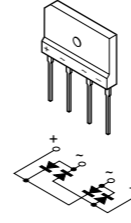

HSU83TRF

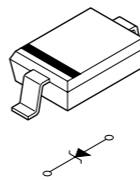

RM11A
RM11C

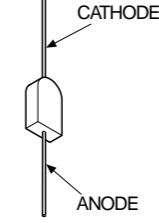

1SS355TE-17

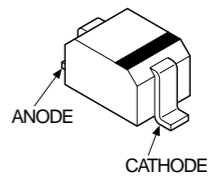

BA10324AF-E2
SN74AHCT74PWR
SN74HC04ANS
SN74HC04ANSR
XRA10324AF

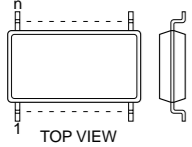

CXD9514M

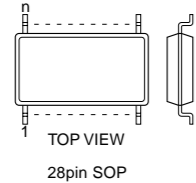

28pin SOP

LA6515

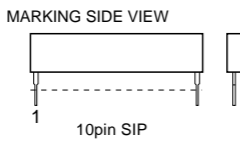

10pin SIP

μPC2912HF (12)

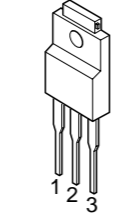

2SA1358-Y
2SC3421-Y

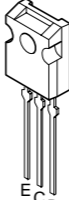

2SD2394-EF

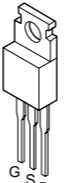

D5SC4M
1PS184-115

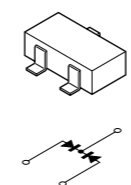

HZS10NB2TD
HZS12NB2TD
HZS13NB2TD
HZS16NB2TD
HZS33NB2
HZS33NB2TD
HZS4.7NB2
HZS4.7NB2TD
HZS5.1NB2TD
HZS5.6NB2TD
MTZJ-T-77-39B
MTZJ-39B
RD10ESB2
RD12ES-B2
RD12ES-T1B2
RD13ES-B2
RD20ES-B2
RD20ES-T1B2
RD22ES-B2
RD22ES-T1B2
RD5.1ESB2
RD5.6ES-T1B2
RD5.6ESB2
RD6.8ES-B2
1SS119-25
1SS119-25TD
1SS133T-77

SPR-325MVW

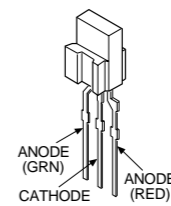

1SS376TE-17

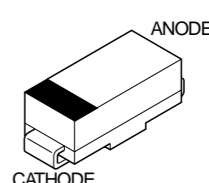

NJM2904M
NJM2904M(TE2)
TL082CPS-E20
NJM082M
24LC21AT/SN

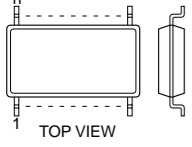

DM-57N

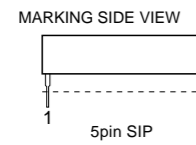

5pin SIP

LA7841L

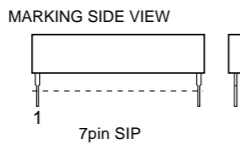

7pin SIP

DTA114GKAT146
DTA114TUA-T106
DTA124EUA-T106
DTC114GKA
DTC114GKAT146
DTC124EK
DTC124EKA-T146
2SA1036K-Q
2SA1036K-T-146-Q
2SA1037AK-T146-QR
2SA1037AK-T146-R
2SA1162-G
2SB709A-QRS-TX
2SC1623-L5L6
2SC2411K-CQ
2SC2411K-T-146-CQ
2SC2412K-T-146-QR

2SB1565EF
2SC3746
2SC5022-02

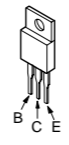

2SJ569LS-CB11
2SK2655-01R-F165
2SK3262-01MR-F119

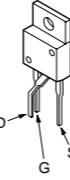

EGP10D
EGP10GPKG23
ERA91-02
ERA91-02TP1

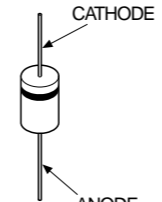

2SK2103T100

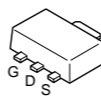

2SC2362K-G
2SC2362KG-AA

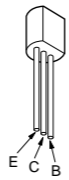

ERA22-06AVRBT
ERA22-08
ERA34-10TP1
ERB38-06V1
GP08D
GP08DPKG23
HSS83TD
P6KE200AG23
RD2.2M-T1B
RGP02-20EL-6394

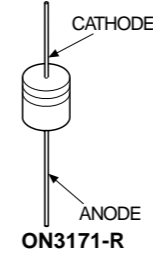

YG911S3R

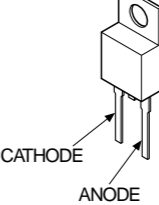

BA9758FS-E2

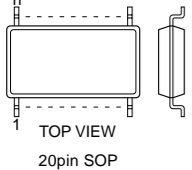

FA4301

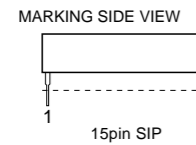

15pin SIP

MZ1530

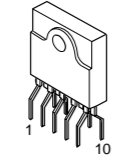

DTA124ESA
DTA124ESA-TP
2SA1175-HFE
2SA1309A-QRSTA
2SC2459-GR-TPE4
2SC2784
2SC2785-HFE
2SC3311A-QRSTA

2SC3209LK
2SC3209LK-TP

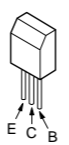

2SK2647-01MR-F91

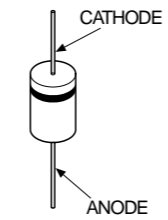
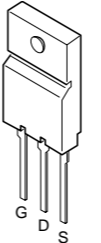

1PS181-115

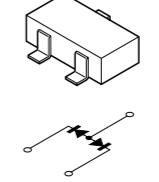

SECTION 6 EXPLODED VIEWS

- Items with no part number and no description are not stocked because they are seldom required for routine service.
- The construction parts of an assembled part are indicated with a collation number in the remark column.
- Items marked " * " are not stocked since they are seldom required for routine service. Some delay should be anticipated when ordering these items.

The components identified \triangle marked are critical for safety.
Replace only with the part number specified.

Les composants identifiés par la marque \triangle sont critiques pour la sécurité.
Ne les remplacer que par une pièce portant le numéro spécifié.

6-1. CHASSIS

- 7-685-648-79 +BVTP 3X12
- 7-685-663-71 +BVTP 4X16
- ◆ 7-685-646-79 +BVTP 3X8
- \triangle 7-685-881-09 +BVTT 4X8

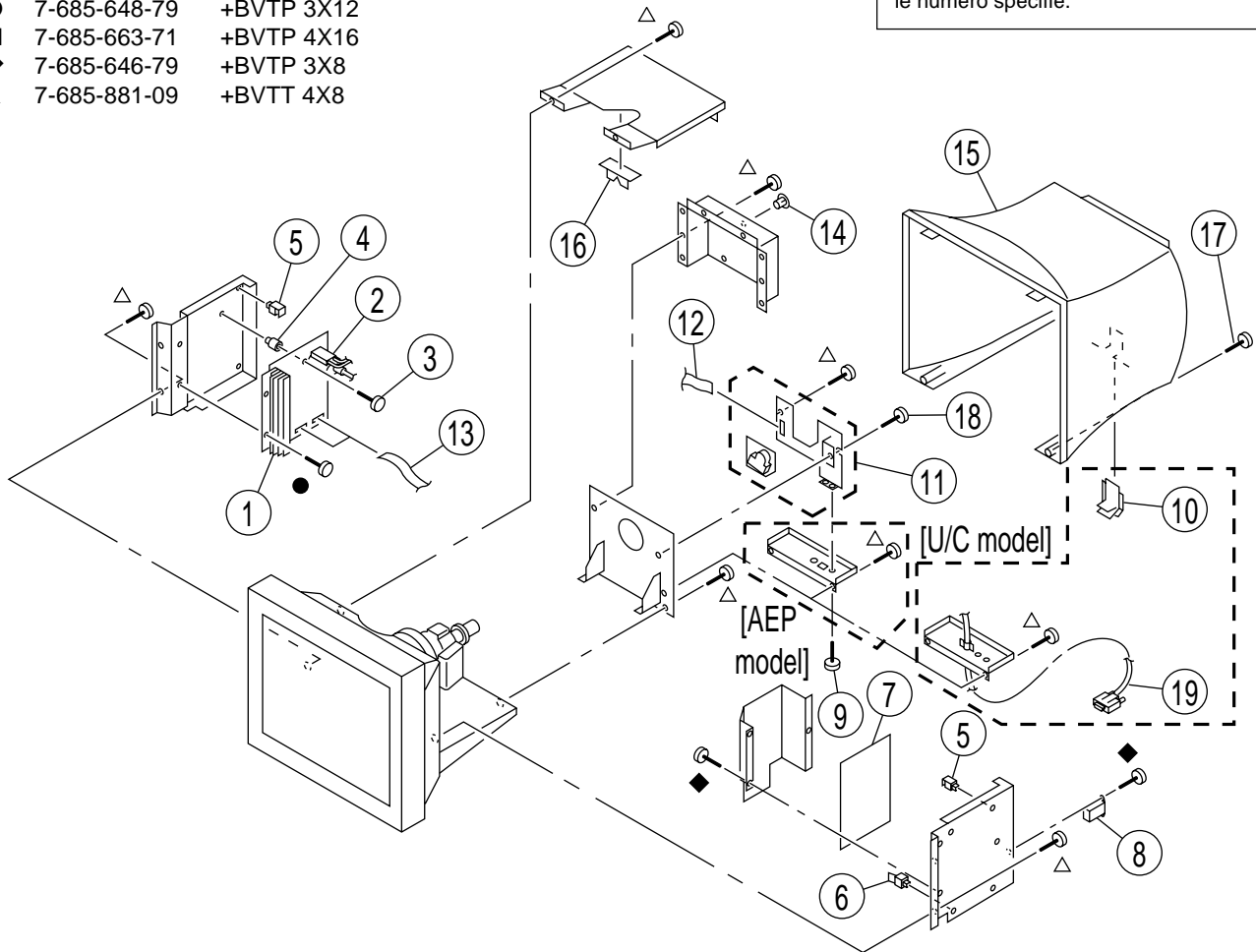

REF.NO.	PART NO.	DESCRIPTION	REMARK	REF.NO.	PART NO.	DESCRIPTION	REMARK
1	* A-1346-859-B	D BOARD, COMPLETE [AEP]	2	9	7-685-881-09	SCREW +BVTP 4X8 (S) [U/C]	
1	* A-1346-827-B	D BOARD, COMPLETE	2	10	4-074-915-01	COVER, PIG TAIL [only U/C]	
		[U/C for Japan-made set]		11	* A-1298-988-B	A BOARD, COMPLETE [AEP]	
1	* A-1346-860-B	D BOARD, COMPLETE	2	11	* A-1299-191-A	A BOARD, COMPLETE	
		[U/C for Mexico-made set]				[U/C for Japan-made set]	
2	\triangle X-4560-175-1	TRANSFORMER ASSY, FLYBACK		11	* A-1299-135-A	A BOARD, COMPLETE	
		(NX-4502//J1D4)				[U/C for Mexico-made set]	
3	4-062-115-01	SCREW +P 3.5X20 TYPE2		12	1-900-246-08	CONNECTOR ASSY (F)	
4	* 4-060-359-01	HOLDER, PRINTED CIRCUIT BOARD		13	1-900-250-06	CONNECTOR ASSY (F)	
5	* 3-701-903-11	HOLDER, PRINTED CIRCUIT BOARD		14	* 4-069-570-01	SPACER, PRINTED CIRCUIT BOARD	
6	4-070-730-01	HOLDER, PRINTED CIRCUIT BOARD		15	4-071-452-11	CABINET [AEP]	
7	* A-1316-480-A	G BOARD, COMPLETE [AEP]		15	4-071-493-11	CABINET [U/C]	
7	* A-1316-443-B	G BOARD, COMPLETE					
		[U/C for Japan-made set]		16	* 4-063-711-01	SUPPORT, HV CABLE	
7	* A-1316-481-A	G BOARD, COMPLETE		17	4-039-358-01	SCREW (4X16), (+) BV TAPPING [AEP]	
		[U/C for Mexico-made set]		17	7-685-663-71	SCREW +BVTP 4X16 TYPE2 IT-3 [U/C]	
8	\triangle 1-251-382-31	INLET, AC 3P (WITH NOISE FILTER)		18	4-389-025-11	SCREW (M4) (EXT TOOTH WASHER)	
9	4-205-206-01	SCREW (HD15) [AEP]		19	1-792-123-11	CORD, CONNECTION [only U/C]	

6-2. PICTURE TUBE

- 7-685-663-71 +BVTP 4X16
- △ 7-685-881-09 +BVTT 4X8

Les composants identifiés par la marque △ sont critiques pour la sécurité. Ne les remplacer que par une pièce portant le numéro spécifié.

The components identified △ marked are critical for safety. Replace only with the part number specified.

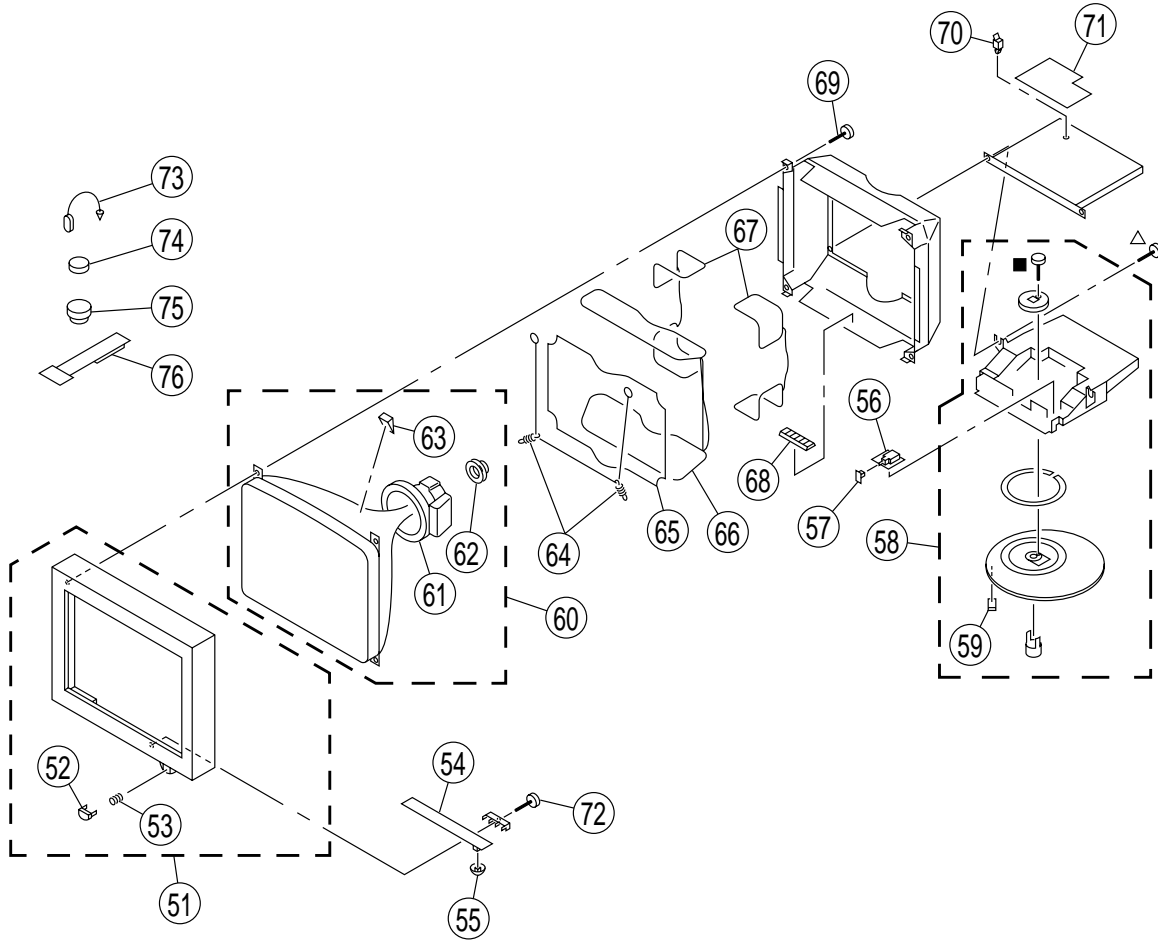

REF.NO.	PART NO.	DESCRIPTION	REMARK	REF.NO.	PART NO.	DESCRIPTION	REMARK
51	X-4037-550-1	BEZEL ASSY [U/C]	52,53	62	△1-452-912-61	NECK ASSEMBLY (NA-2914)	
51	X-4200-569-1	BEZEL ASSY [AEP]	52,53	63	2-162-100-21	SPACER, DEFLECTION YOKE	
52	4-071-152-22	BUTTON, POWER [U/C]		64	* 4-047-316-01	SPRING, EXTENSION	
52	4-204-957-01	BUTTON, POWER [AEP]		64	* 4-061-573-01	SPRING, TENSION	[U/C for Japan-made set, AEP]
53	3-653-339-21	SPRING, COMPRESSION [U/C]		64	* 4-061-573-01	SPRING, TENSION	[U/C for Mexico-made set]
53	3-653-339-11	SPRING, COMPRESSION [AEP]		65	△1-419-130-21	COIL, LANDING CORRECTION	
54	* A-1372-799-A	H1 BOARD, COMPLETE		66	△1-419-128-21	COIL, DEGAUSSING	
		[U/C for Japan-made set]		67	△1-419-129-21	COIL, LANDING CORRECTION	
54	* A-1372-770-A	H1 BOARD, COMPLETE		68	4-062-670-01	SPACER, PICTURE TUBE	
		[U/C for Mexico-made set]		69	4-203-648-01	SCREW (5), SELF TAPPING [AEP]	
54	* A-1646-206-A	H1 BOARD, COMPLETE [AEP]		69	4-365-808-01	SCREW (5), TAPPING [U/C]	
55	4-070-665-02	BUTTON, MENU		70	4-070-730-01	HOLDER, PRINTED CIRCUIT BOARD	
		[U/C for Japan-made set]		71	* A-1394-950-B	N BOARD, COMPLETE [AEP]	
55	4-071-155-02	BUTTON, MENU		71	* A-1394-984-A	N BOARD, COMPLETE	
		[U/C for Mexico-made set]				[U/C for Japan-made set]	
55	4-204-970-01	BUTTON, MENU [AEP]		71	* A-1394-973-A	N BOARD, COMPLETE	[U/C for Mexico-made set]
56	* A-1388-260-B	J BOARD, COMPLETE [AEP]		72	7-685-663-71	SCREW +BVTP 4X16 TYPE2 IT-3 [U/C]	
56	* A-1388-250-B	J BOARD, COMPLETE		72	4-039-358-01	SCREW (4X16), (+) BV TAPPING [AEP]	
		[U/C for Japan-made set]		73	4-308-870-00	CLIP, LEAD WIRE	
56	* A-1388-261-B	J BOARD, COMPLETE		74	1-452-032-00	MAGNET, DISK; 10mm φ	
		[U/C for Mexico-made set]		75	1-452-094-00	MAGNET, ROTATABLE DISK; 15mm φ	
57	* 4-394-972-21	CAP, POWER		76	4-051-736-21	PIECE A (90), CONV. CORRECT	
58	X-4036-844-2	STAND ASSY	59				
59	* 4-061-996-11	CUSHION					
60	△8-738-813-61	ITC ASSY (21TKC-R1)	61-63				
61	△8-451-509-11	DEFLECTION YOKE Y21TKM-M					

6-3. PACKING MATERIALS

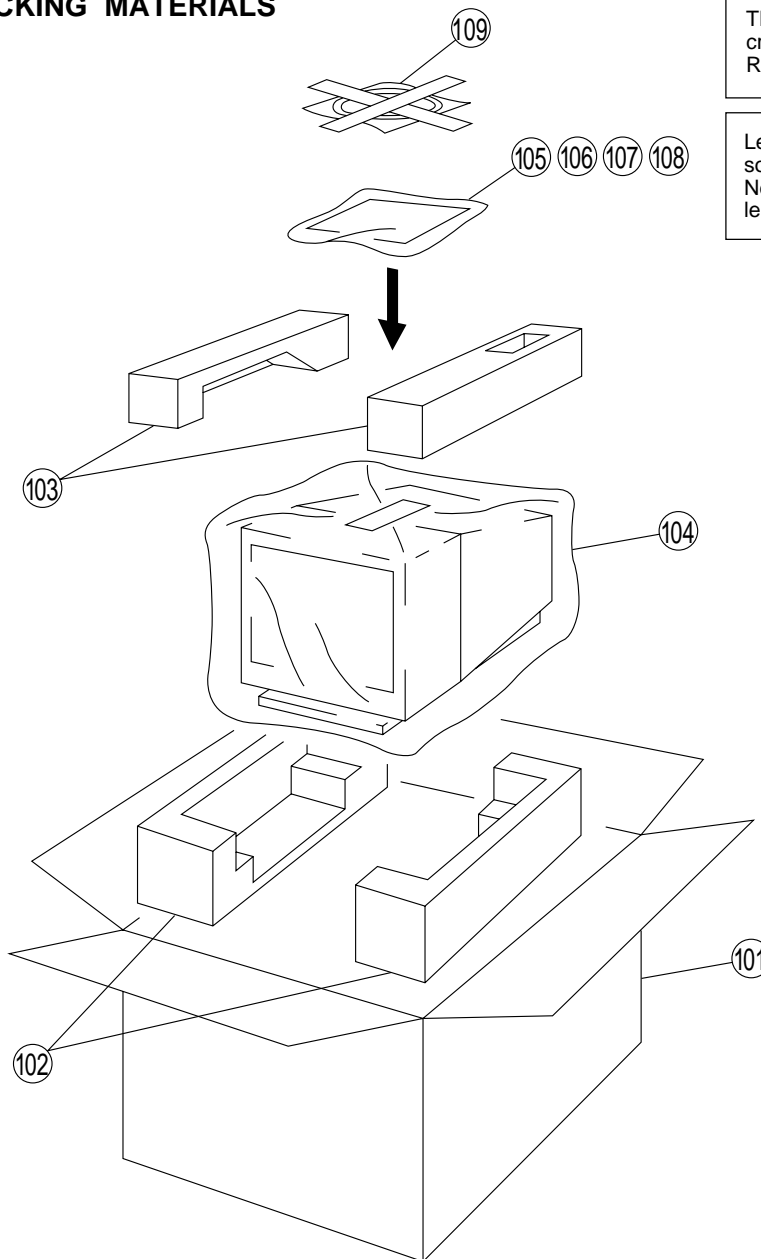

The components identified \triangle marked are critical for safety. Replace only with the part number specified.

Les composants identifiés par la marque \triangle sont critiques pour la sécurité. Ne les remplacer que par une pièce portant le numéro spécifié.

REF.NO.	PART NO.	DESCRIPTION	REMARK	REF.NO.	PART NO.	DESCRIPTION	REMARK
101	* 4-075-604-01	INDIVIDUAL CARTON [U/C for Japan-made set]		104	* 4-047-293-01	BAG, POLYETHYLENE [U/C for Mexico-made set]	
101	* 4-074-479-01	INDIVIDUAL CARTON [U/C for Mexico-made set]		104	* 4-368-079-01	BAG, POLYETHYLENE [AEP]	
101	* 4-205-252-01	CARTON [AEP]		105	\triangle 1-782-783-31	CORD SET, POWER [U/C]	
102	* 4-071-781-01	CUSHION (LOWER) (ASSY) [AEP]		105	\triangle 1-782-784-21	CORD SET, POWER [AEP]	
102	* 4-071-731-01	CUSHION (LOWER) (ASSY) [U/C for Japan-made set]		106	4-075-164-11	MANUAL, INSTRUCTION [U/C]	
102	* 4-072-876-01	CUSHION (LOWER) (ASSY) [U/C for Mexico-made set]		106	4-075-164-21	MANUAL, INSTRUCTION [AEP]	
103	* 4-071-780-01	CUSHION (UPPER) (ASSY) [AEP]		107	1-772-380-11	DISK, INFORMATION [AEP]	
103	* 4-071-730-01	CUSHION (UPPER) (ASSY) [U/C for Japan-made set]		107	1-772-380-21	DISK, INFORMATION [U/C]	
103	* 4-072-875-01	CUSHION (UPPER) (ASSY) [U/C for Mexico-made set]		108	1-785-512-21	CONNECTOR, DSUB (15P CHANGER) [U/C]	
104	* 4-041-927-31	BAG, POLYETHYLENE [U/C for Japan-made set]		108	1-785-512-31	CONNECTOR, DSUB (15P CHANGER) [AEP]	
				109	1-791-500-11	CABLE [only AEP]	

SECTION 7 ELECTRICAL PARTS LIST



NOTE:

The components identified Δ marked are critical for safety. Replace only with the part number specified.

Les composants identifiés par la marque Δ sont critiques pour la sécurité. Ne les remplacer que par une pièce portant le numéro spécifié.

When indicating parts by reference number, please include the board name.

The components identified by \square in this manual have been carefully factory-selected for each set in order to satisfy regulations regarding X-ray radiation. Should replacement be required, replace only with the value originally used.

• All variable and adjustable resistors have characteristic curve B, unless otherwise noted.

• Items marked " * " are not stocked since they are seldom required for routine service. Some delay should be anticipated when ordering these items.

RESISTORS

• All resistors are in ohms
• F : nonflammable

REF.NO.	PART NO.	DESCRIPTION	REMARK	REF.NO.	PART NO.	DESCRIPTION	REMARK
	* A-1298-988-B	A BOARD, COMPLETE	[AEP]	C302	1-104-664-11	ELECT 47 μ F	20% 25V
	* A-1299-135-A	A BOARD, COMPLETE		C303	1-163-021-91	CERAMIC CHIP 0.01 μ F	10% 50V
		[U/C for Mexico-made set]					[AEP]
	* A-1299-191-A	A BOARD, COMPLETE		C304	1-104-664-11	ELECT 47 μ F	20% 25V
		[U/C for Japan-made set]					[AEP]
	*****			C307	1-164-004-11	CERAMIC CHIP 0.1 μ F	10% 25V
	7-682-950-01	SCREW +PSW 3X12 (IC403)		C308	1-164-004-11	CERAMIC CHIP 0.1 μ F	10% 25V
	<CAPACITOR>			C309	1-163-227-11	CERAMIC CHIP 10pF	0.5pF 50V
	C101	1-163-021-91 CERAMIC CHIP 0.01 μ F	10% 50V	C310	1-163-275-11	CERAMIC CHIP 0.001 μ F	5% 50V
	C102	1-104-664-11 ELECT 47 μ F	20% 25V	C312	1-164-489-11	CERAMIC CHIP 0.22 μ F	10% 16V
	C103	1-163-021-91 CERAMIC CHIP 0.01 μ F	10% 50V	C313	1-164-489-11	CERAMIC CHIP 0.22 μ F	10% 16V
			[AEP]	C314	1-164-004-11	CERAMIC CHIP 0.1 μ F	10% 25V
	C104	1-104-664-11 ELECT 47 μ F	20% 25V	C315	1-104-341-11	FILM 0.1 μ F	10% 250V
			[AEP]	C320	1-104-341-11	FILM 0.1 μ F	10% 250V
	C107	1-164-004-11 CERAMIC CHIP 0.1 μ F	10% 25V	C401	1-126-964-11	ELECT 10 μ F	20% 50V
	C108	1-164-004-11 CERAMIC CHIP 0.1 μ F	10% 25V	C402	1-104-664-11	ELECT 47 μ F	20% 25V
	C109	1-163-229-11 CERAMIC CHIP 12pF	5% 50V	C403	1-163-259-91	CERAMIC CHIP 220pF	5% 50V
	C110	1-163-275-11 CERAMIC CHIP 0.001 μ F	5% 50V	C404	1-163-259-91	CERAMIC CHIP 220pF	5% 50V
	C112	1-164-489-11 CERAMIC CHIP 0.22 μ F	10% 16V	C405	1-164-004-11	CERAMIC CHIP 0.1 μ F	10% 25V
	C113	1-164-489-11 CERAMIC CHIP 0.22 μ F	10% 16V	C406	1-163-021-91	CERAMIC CHIP 0.01 μ F	10% 50V
	C114	1-164-004-11 CERAMIC CHIP 0.1 μ F	10% 25V	C407	1-163-021-91	CERAMIC CHIP 0.01 μ F	10% 50V
	C115	1-104-341-11 FILM 0.1 μ F	10% 250V	C408	1-163-021-91	CERAMIC CHIP 0.01 μ F	10% 50V
	C120	1-104-341-11 FILM 0.1 μ F	10% 250V	C410	1-163-021-91	CERAMIC CHIP 0.01 μ F	10% 50V
	C201	1-163-021-91 CERAMIC CHIP 0.01 μ F	10% 50V	C411	1-104-664-11	ELECT 47 μ F	20% 25V
	C202	1-104-664-11 ELECT 47 μ F	20% 25V				[U/C]
				C411	1-126-934-11	ELECT 220 μ F	20% 16V
	C203	1-163-021-91 CERAMIC CHIP 0.01 μ F	10% 50V				[AEP]
			[AEP]	C413	1-163-021-91	CERAMIC CHIP 0.01 μ F	10% 50V
	C204	1-104-664-11 ELECT 47 μ F	20% 25V				[AEP]
			[AEP]	C413	1-216-025-91	RES, CHIP 100	5% 1/10W
	C205	1-163-021-91 CERAMIC CHIP 0.01 μ F	10% 50V				[U/C]
	C206	1-109-982-11 CERAMIC CHIP 1 μ F	10% 10V	C415	1-164-489-11	CERAMIC CHIP 0.22 μ F	10% 16V
	C207	1-164-004-11 CERAMIC CHIP 0.1 μ F	10% 25V	C416	1-126-961-11	ELECT 2.2 μ F	20% 50V
	C208	1-164-004-11 CERAMIC CHIP 0.1 μ F	10% 25V	C417	1-104-574-11	CERAMIC 0.0047 μ F	10% 2KV
	C209	1-163-227-11 CERAMIC CHIP 10pF	0.5pF 50V	C419	1-162-318-11	CERAMIC 0.001 μ F	10% 500V
	C210	1-163-275-11 CERAMIC CHIP 0.001 μ F	5% 50V	C420	1-164-489-11	CERAMIC CHIP 0.22 μ F	10% 16V
	C212	1-164-489-11 CERAMIC CHIP 0.22 μ F	10% 16V	C421	1-163-021-91	CERAMIC CHIP 0.01 μ F	10% 50V
	C213	1-164-489-11 CERAMIC CHIP 0.22 μ F	10% 16V	C422	1-164-489-11	CERAMIC CHIP 0.22 μ F	10% 16V
	C214	1-164-004-11 CERAMIC CHIP 0.1 μ F	10% 25V	C423	1-104-664-11	ELECT 47 μ F	20% 25V
	C215	1-104-341-11 FILM 0.1 μ F	10% 250V	C424	1-162-318-11	CERAMIC 0.001 μ F	10% 500V
	C216	1-163-021-91 CERAMIC CHIP 0.01 μ F	10% 50V	C425	1-163-251-11	CERAMIC CHIP 100pF	5% 50V
	C220	1-104-341-11 FILM 0.1 μ F	10% 250V	C426	1-163-251-11	CERAMIC CHIP 100pF	5% 50V
	C301	1-163-021-91 CERAMIC CHIP 0.01 μ F	10% 50V	C427	1-163-235-11	CERAMIC CHIP 22pF	5% 50V
				C430	1-163-021-91	CERAMIC CHIP 0.01 μ F	10% 50V



Les composants identifiés par la marque Δ sont critiques pour la sécurité.
Ne les remplacer que par une pièce portant le numéro spécifié.

The components identified Δ marked are critical for safety.
Replace only with the part number specified.

REF.NO.	PART NO.	DESCRIPTION	REMARK	REF.NO.	PART NO.	DESCRIPTION	REMARK
C431	1-163-275-11	CERAMIC CHIP0.001 μ F	5% 50V	D402	8-719-066-11	DIODE 1PS184-115	
C432	1-164-489-11	CERAMIC CHIP0.22 μ F	10% 16V	D403	8-719-982-36	ZENER DIODE MTZJ-39B	
C433	1-162-318-11	CERAMIC 0.001 μ F	10% 500V	D405	8-719-911-19	DIODE 1SS119-25	
C434	1-162-318-11	CERAMIC 0.001 μ F	10% 500V	D406	8-719-062-51	DIODE 1PS226-115	
C435	1-163-021-91	CERAMIC CHIP0.01 μ F	10% 50V	D407	8-719-062-51	DIODE 1PS226-115	
C436	1-164-489-11	CERAMIC CHIP0.22 μ F	10% 16V				
C437	1-126-934-11	ELECT 220 μ F	20% 16V				
			[U/C]			<FERRITE BEAD>	
C437	1-126-935-11	ELECT 470 μ F	20% 16V	FB102	1-500-419-22	FERRITE	
			[AEP]	FB202	1-500-419-22	FERRITE	
C438	1-115-339-11	CERAMIC CHIP0.1 μ F	10% 50V	FB302	1-500-419-22	FERRITE	
C440	1-163-021-91	CERAMIC CHIP0.01 μ F	10% 50V	FB402	1-412-911-11	FERRITE 1.1 μ H	
C441	1-163-021-91	CERAMIC CHIP0.01 μ F	10% 50V	FB403	1-412-911-11	FERRITE 1.1 μ H	
C442	1-163-021-91	CERAMIC CHIP0.01 μ F	10% 50V				
C443	1-163-021-91	CERAMIC CHIP0.01 μ F	10% 50V	FB404	1-412-911-11	FERRITE 1.1 μ H	
C444	1-162-318-11	CERAMIC 0.001 μ F	10% 500V	FB405	1-412-911-11	FERRITE 1.1 μ H	
C446	1-104-664-11	ELECT 47 μ F	20% 25V	FB406	1-412-911-11	FERRITE 1.1 μ H	
C449	1-109-982-11	CERAMIC CHIP1 μ F	10% 10V	FB411	1-412-911-11	FERRITE 1.1 μ H	
C450	1-107-823-11	CERAMIC CHIP0.47 μ F	10% 16V				
						<IC>	
C456	1-164-489-11	CERAMIC CHIP0.22 μ F	10% 16V	IC401	8-759-584-87	IC M52757FP-TP	
			[AEP]	IC402	8-759-584-86	IC M52749FP-TP	
C457	1-163-021-91	CERAMIC CHIP0.01 μ F	10% 50V	IC403	8-749-015-91	IC FA4301	
C458	1-115-339-11	CERAMIC CHIP0.1 μ F	10% 50V	IC404	8-759-585-72	IC CXD9514M	
C459	1-128-560-11	ELECT 22 μ F	20% 100V	IC405	8-759-701-01	IC NJM2904M	
C462	1-115-339-11	CERAMIC CHIP0.1 μ F	10% 50V				
C463	1-163-021-91	CERAMIC CHIP0.01 μ F	10% 50V	IC406	8-749-015-92	IC H8D2972	
C464	1-163-021-91	CERAMIC CHIP0.01 μ F	10% 50V	IC407	8-759-925-74	IC SN74HC04ANS	
C467	1-107-957-11	ELECT 1 μ F	20% 250V				
						<COIL>	
		<CONNECTOR>		L402	1-412-529-11	INDUCTOR 22 μ H	
CN401	1-793-183-11	CONNECTOR, D SUB 15P [AEP]		L403	1-412-537-31	INDUCTOR 100 μ H	
CN402*	1-564-509-11	PLUG, CONNECTOR 6P		L404	1-414-940-21	INDUCTOR 100 μ H	
CN403	1-784-463-11	CONNECTOR, FFC/FPC 21P		L405	1-412-529-11	INDUCTOR 22 μ H	
CN405*	1-564-524-11	PLUG, CONNECTOR 9P					
CN406*	1-766-179-11	PIN, CONNECTOR (PC BOARD) 2P				<IC LINK>	
				PS401 Δ 1	533-590-31	LINK, IC (1A/90V AC, 60V DC)	
		<DIODE>					
D101	8-719-062-51	DIODE 1PS226-115				<TRANSISTOR>	
D102	8-719-062-51	DIODE 1PS226-115 [AEP]		Q101	8-729-120-28	TRANSISTOR 2SC1623-L5L6	
D103	8-719-066-10	DIODE 1PS181-115		Q201	8-729-120-28	TRANSISTOR 2SC1623-L5L6	
D105	8-719-051-85	DIODE HSS83TD		Q301	8-729-120-28	TRANSISTOR 2SC1623-L5L6	
D106	8-719-052-12	DIODE 1SS376TE-17		Q401	8-729-120-28	TRANSISTOR 2SC1623-L5L6	
				Q402	8-729-050-41	TRANSISTOR 2SJ360TE12L	
D107	8-719-052-12	DIODE 1SS376TE-17					
D201	8-719-062-51	DIODE 1PS226-115		Q406	8-729-216-22	TRANSISTOR 2SA1162-G	
D202	8-719-062-51	DIODE 1PS226-115 [AEP]		Q407	8-729-028-74	TRANSISTOR DTA114TUA-T106	
D203	8-719-066-10	DIODE 1PS181-115		Q410	8-729-032-61	TRANSISTOR 2SC5022-02	
D205	8-719-051-85	DIODE HSS83TD					
						<RESISTOR>	
D206	8-719-052-12	DIODE 1SS376TE-17		R101	1-215-394-00	METAL 75 1% 1/4W	
D207	8-719-052-12	DIODE 1SS376TE-17		R103	1-215-394-00	METAL 75 1% 1/4W	
D301	8-719-062-51	DIODE 1PS226-115					
D302	8-719-062-51	DIODE 1PS226-115 [AEP]		R105	1-216-017-91	RES,CHIP 47 5% 1/10W	
D303	8-719-066-10	DIODE 1PS181-115		R106	1-216-017-91	RES,CHIP 47 5% 1/10W	
							[AEP]
D305	8-719-051-85	DIODE HSS83TD					
D306	8-719-052-12	DIODE 1SS376TE-17					
D307	8-719-052-12	DIODE 1SS376TE-17					[AEP]



REF.NO.	PART NO.	DESCRIPTION	REMARK	REF.NO.	PART NO.	DESCRIPTION	REMARK
R107	1-216-045-00	RES,CHIP	680 5% 1/10W	R311	1-216-033-00	RES,CHIP	220 5% 1/10W
R109	1-216-678-11	METAL CHIP	13K 0.5% 1/10W	R312	1-216-009-91	RES,CHIP	22 5% 1/10W
R110	1-216-097-91	RES,CHIP	100K 5% 1/10W	R313	1-216-017-91	RES,CHIP	47 5% 1/10W
R111	1-216-041-00	RES,CHIP	470 5% 1/10W	R314	1-216-009-91	RES,CHIP	22 5% 1/10W
R112	1-216-009-91	RES,CHIP	22 5% 1/10W	R315	1-219-742-11	CARBON	47 5% 1/2W
R113	1-216-017-91	RES,CHIP	47 5% 1/10W	R316	1-216-065-91	RES,CHIP	4.7K 5% 1/10W
R114	1-216-009-91	RES,CHIP	22 5% 1/10W	R317	1-216-121-91	RES,CHIP	1M 5% 1/10W
R115	1-219-742-11	CARBON	47 5% 1/2W	R318	1-216-121-91	RES,CHIP	1M 5% 1/10W
R116	1-216-065-91	RES,CHIP	4.7K 5% 1/10W	R319	1-216-077-91	RES,CHIP	15K 5% 1/10W
R117	1-216-121-91	RES,CHIP	1M 5% 1/10W	R320	1-216-113-00	RES,CHIP	470K 5% 1/10W
R118	1-216-121-91	RES,CHIP	1M 5% 1/10W	R321	1-216-113-00	RES,CHIP	470K 5% 1/10W
R119	1-216-077-91	RES,CHIP	15K 5% 1/10W	R322	1-216-081-00	RES,CHIP	22K 5% 1/10W
R120	1-216-113-00	RES,CHIP	470K 5% 1/10W	R328	1-216-065-91	RES,CHIP	4.7K 5% 1/10W
R121	1-216-113-00	RES,CHIP	470K 5% 1/10W	R330	1-216-113-00	RES,CHIP	470K 5% 1/10W
R122	1-216-081-00	RES,CHIP	22K 5% 1/10W	R337	1-249-413-11	CARBON	470 5% 1/4W
R128	1-216-065-91	RES,CHIP	4.7K 5% 1/10W	R338	1-216-017-91	RES,CHIP	47 5% 1/10W
R130	1-216-113-00	RES,CHIP	470K 5% 1/10W	R361	1-216-041-00	RES,CHIP	470 5% 1/10W
R137	1-249-413-11	CARBON	470 5% 1/4W	R402	1-216-049-91	RES,CHIP	1K 5% 1/10W
R138	1-216-017-91	RES,CHIP	47 5% 1/10W	R403	1-216-081-00	RES,CHIP	22K 5% 1/10W
R161	1-216-041-00	RES,CHIP	470 5% 1/10W	R404	1-216-057-00	RES,CHIP	2.2K 5% 1/10W
R201	1-215-394-00	METAL	75 1% 1/4W	R405	1-216-045-00	RES,CHIP	680 5% 1/10W
R202	1-216-097-91	RES,CHIP	100K 5% 1/10W	R406	1-216-097-91	RES,CHIP	100K 5% 1/10W
R203	1-215-394-00	METAL	75 1% 1/4W	R407	1-218-768-11	METAL CHIP	470K 0.5% 1/10W
R205	1-216-017-91	RES,CHIP	47 5% 1/10W	R409	1-216-129-00	RES,CHIP	2.2M 5% 1/10W
R206	1-216-017-91	RES,CHIP	47 5% 1/10W	R411	1-216-065-91	RES,CHIP	4.7K 5% 1/10W
R207	1-216-045-00	RES,CHIP	680 5% 1/10W	R412	1-216-105-91	RES,CHIP	220K 5% 1/10W
R209	1-216-678-11	METAL CHIP	13K 0.5% 1/10W	R413	1-216-097-91	RES,CHIP	100K 5% 1/10W
R210	1-216-097-91	RES,CHIP	100K 5% 1/10W	R414	1-216-089-91	RES,CHIP	47K 5% 1/10W
R211	1-216-033-00	RES,CHIP	220 5% 1/10W	R415	1-216-097-91	RES,CHIP	100K 5% 1/10W
R212	1-216-009-91	RES,CHIP	22 5% 1/10W	R417	1-216-121-91	RES,CHIP	1M 5% 1/10W
R213	1-216-017-91	RES,CHIP	47 5% 1/10W	R418	1-260-127-11	CARBON	220K 5% 1/2W
R214	1-216-009-91	RES,CHIP	22 5% 1/10W	R419	1-216-033-00	RES,CHIP	220 5% 1/10W
R215	1-219-742-11	CARBON	47 5% 1/2W	R420	1-216-025-91	RES,CHIP	100 5% 1/10W
R216	1-216-065-91	RES,CHIP	4.7K 5% 1/10W	R421	1-216-025-91	RES,CHIP	100 5% 1/10W
R217	1-216-121-91	RES,CHIP	1M 5% 1/10W	R422	1-216-025-91	RES,CHIP	100 5% 1/10W
R218	1-216-121-91	RES,CHIP	1M 5% 1/10W	R424	1-216-049-91	RES,CHIP	1K 5% 1/10W
R219	1-216-077-91	RES,CHIP	15K 5% 1/10W	R425	1-216-049-91	RES,CHIP	1K 5% 1/10W
R220	1-216-113-00	RES,CHIP	470K 5% 1/10W	R426	1-216-105-91	RES,CHIP	220K 5% 1/10W
R221	1-216-113-00	RES,CHIP	470K 5% 1/10W	R427	1-216-049-91	RES,CHIP	1K 5% 1/10W
R222	1-216-081-00	RES,CHIP	22K 5% 1/10W	R428	1-216-025-91	RES,CHIP	100 5% 1/10W
R228	1-216-065-91	RES,CHIP	4.7K 5% 1/10W	R430	1-216-025-91	RES,CHIP	100 5% 1/10W
R230	1-216-113-00	RES,CHIP	470K 5% 1/10W	R431	1-216-113-00	RES,CHIP	470K 5% 1/10W
R237	1-249-413-11	CARBON	470 5% 1/4W	R436	1-216-057-00	RES,CHIP	2.2K 5% 1/10W
R238	1-216-017-91	RES,CHIP	47 5% 1/10W	R438	1-216-065-91	RES,CHIP	4.7K 5% 1/10W
R261	1-216-041-00	RES,CHIP	470 5% 1/10W	R439	1-216-041-00	RES,CHIP	470 5% 1/10W
R301	1-215-394-00	METAL	75 1% 1/4W	R441	1-216-121-91	RES,CHIP	1M 5% 1/10W
R303	1-215-394-00	METAL	75 1% 1/4W	R442	1-216-049-91	RES,CHIP	1K 5% 1/10W
R305	1-216-017-91	RES,CHIP	47 5% 1/10W	R443	1-216-025-91	RES,CHIP	100 5% 1/10W
R306	1-216-017-91	RES,CHIP	47 5% 1/10W	R444	1-216-025-91	RES,CHIP	100 5% 1/10W
R307	1-216-045-00	RES,CHIP	680 5% 1/10W	R445	1-216-025-91	RES,CHIP	100 5% 1/10W
R309	1-216-678-11	METAL CHIP	13K 0.5% 1/10W	R446	1-216-025-91	RES,CHIP	100 5% 1/10W
R310	1-216-097-91	RES,CHIP	100K 5% 1/10W	R447	1-216-017-91	RES,CHIP	47 5% 1/10W
				R448	1-216-017-91	RES,CHIP	47 5% 1/10W

The components identified Δ marked are critical for safety.
Replace only with the part number specified.

Les composants identifiés par la marque Δ sont critiques pour la sécurité.
Ne les remplacer que par une pièce portant le numéro spécifié.



REF.NO.	PART NO.	DESCRIPTION	REMARK	REF.NO.	PART NO.	DESCRIPTION	REMARK
<DIODE>				L651	1-414-742-21	INDUCTOR	22 μ H
D610	Δ 8-719-510-53	DIODE D4SB60L		L652	1-412-529-11	INDUCTOR	22 μ H
D612	8-719-911-19	DIODE 1SS119-25		L653	1-412-529-11	INDUCTOR	22 μ H
D613	8-719-304-63	DIODE RM11C		L680	1-414-742-21	INDUCTOR	22 μ H
D620	8-719-911-19	DIODE 1SS119-25		<PHOTO COUPLER>			
D631	8-719-063-73	DIODE D1NL20U-TR		PH620	8-749-924-35	PHOTO COUPLER ON3171-R	
D632	8-719-059-23	DIODE P6KE200AG23		PH630	8-749-924-35	PHOTO COUPLER ON3171-R	
D633	8-719-069-63	DIODE ERB38-06V1		<IC LINK>			
D634	8-719-911-19	DIODE 1SS119-25		PS650	Δ 1-533-593-31	LINK, IC (2A/90V AC, 60V DC)	
D635	8-719-110-53	ZENER DIODE RD20ESB2		<TRANSISTOR>			
D637	8-719-911-19	DIODE 1SS119-25		Q603	8-729-045-39	TRANSISTOR MX0842AB-F	
D650	8-719-064-49	DIODE D4SBL40		Q610	8-729-119-76	TRANSISTOR 2SA1175-HFE	
D651	8-719-063-73	DIODE D1NL20U-TR		Q621	8-729-119-78	TRANSISTOR 2SC2785-HFE	
D652	8-719-052-91	DIODE D4SBS4-F		Q630	8-729-045-03	TRANSISTOR 2SK2647-01MR-F91	
D653	8-719-022-97	DIODE D2S4MF		Q631	8-729-041-66	TRANSISTOR 2SC4015TV2	
D654	8-719-022-97	DIODE D2S4MF		Q632	8-729-041-66	TRANSISTOR 2SC4015TV2	
D655	8-719-063-73	DIODE D1NL20U-TR		Q633	8-729-120-28	TRANSISTOR 2SC1623-L5L6	
D656	8-719-911-19	DIODE 1SS119-25		Q650	8-729-119-76	TRANSISTOR 2SA1175-HFE	
D660	8-719-110-57	ZENER DIODE RD22ESB2		Q651	8-729-230-45	TRANSISTOR 2SC2458-YGR	
D661	8-719-110-31	ZENER DIODE RD12ESB2		Q652	8-729-120-28	TRANSISTOR 2SC1623-L5L6	
D663	8-719-911-19	DIODE 1SS119-25		Q653	8-729-120-28	TRANSISTOR 2SC1623-L5L6	
D664	8-719-110-57	ZENER DIODE RD22ESB2		Q654	8-729-026-49	TRANSISTOR 2SA1037AK-T146-R	
D665	8-719-911-19	DIODE 1SS119-25		Q667	8-729-026-49	TRANSISTOR 2SA1037AK-T146-R	
D666	8-719-911-19	DIODE 1SS119-25		Q670	8-729-026-49	TRANSISTOR 2SA1037AK-T146-R	
D680	8-719-989-87	DIODE YG802C09		Q671	8-729-026-49	TRANSISTOR 2SA1037AK-T146-R	
D681	8-719-109-89	ZENER DIODE RD5.6ESB2		Q691	8-729-119-78	TRANSISTOR 2SC2785-HFE	
D682	8-719-121-26	ZENER DIODE RD9.1ESL2		<RESISTOR>			
D683	8-719-911-19	DIODE 1SS119-25		R601	Δ 1-220-825-91	CARBON	330K 5% 1/2W
D690	8-719-911-19	DIODE 1SS119-25		R602	1-216-465-11	METAL OXIDE	27K 5% 2W F
D692	8-719-911-19	DIODE 1SS119-25		R603	1-247-895-91	CARBON	470K 5% 1/4W
<FUSE>				R604	1-216-113-00	RES,CHIP	470K 5% 1/10W
F601	Δ 1-576-233-11	FUSE (H.B.C.) (6.3A/250V)		R605	1-216-113-00	RES,CHIP	470K 5% 1/10W
<FERRITE BEAD>				R606	1-216-097-91	RES,CHIP	100K 5% 1/10W
FB630	1-410-396-41	FERRITE	0.45 μ H	R607	1-216-097-91	RES,CHIP	100K 5% 1/10W
FB632	Δ 1-410-397-31	FERRITE	1.1 μ H	R608	1-216-073-00	RES,CHIP	10K 5% 1/10W
<IC>				R609	1-216-069-00	RES,CHIP	6.8K 5% 1/10W
IC610	8-749-015-89	IC MZ1530		R610	1-217-152-00	METAL	0.33 10% 2W
IC630	8-759-535-32	IC FA13842P		R611	1-217-153-00	METAL	0.47 10% 2W
IC650	8-749-012-49	IC DM-57N		R612	1-249-429-11	CARBON	10K 5% 1/4W
IC651	8-759-592-79	IC BA00AST-V5		R613	1-216-089-91	RES,CHIP	47K 5% 1/10W
IC652	8-759-496-15	IC BA05ST-V5		R614	1-247-807-31	CARBON	100 5% 1/4W
IC653	8-759-450-47	IC BA05T		R615	1-249-427-11	CARBON	6.8K 5% 1/4W
IC654	8-759-643-66	IC μ PC2912HF(12)		R616	1-216-671-11	METAL CHIP	6.8K 0.5% 1/10W
IC680	8-759-321-95	IC HA17431PA		R617	1-249-417-11	CARBON	1K 5% 1/4W
<COIL>				R618	1-216-369-00	METAL OXIDE	1 5% 2W F
L610	1-419-126-21	COIL, CHOKE (AFC)	216 μ H	R620	1-202-933-61	FUSIBLE	0.1 10% 1/2W F
L611	1-411-674-11	INDUCTOR	68 μ H	R621	1-249-432-11	CARBON	18K 5% 1/4W
L650	1-414-742-21	INDUCTOR	22 μ H				



REF.NO.	PART NO.	DESCRIPTION	REMARK	REF.NO.	PART NO.	DESCRIPTION	REMARK
C508	1-126-965-11	ELECT	22μF 20% 50V	C565	1-164-004-11	CERAMIC CHIP0.1μF	10% 25V
C509	1-115-521-11	FILM	0.82μF 5% 250V	C566	1-137-370-11	FILM 0.01μF	5% 50V
C510	1-117-398-11	ELECT	33μF 20% 250V	C567	1-164-161-11	CERAMIC CHIP0.0022μF	10% 50V
C511	1-163-113-00	CERAMIC CHIP	68pF 5% 50V	C568	1-104-760-11	CERAMIC CHIP0.047μF	10% 50V
C512	1-163-259-91	CERAMIC CHIP	220pF 5% 50V	C571	1-163-227-11	CERAMIC CHIP10pF	0.5pF 50V
C513	1-163-017-00	CERAMIC CHIP	0.0047μF 10% 50V	C572	1-163-009-11	CERAMIC CHIP0.001μF	10% 50V
C514	1-106-375-12	MYLAR	0.022μF 200V	C573	1-106-375-12	MYLAR 0.022μF	200V
C515	1-163-021-91	CERAMIC CHIP	0.01μF 10% 50V	C574	1-163-017-00	CERAMIC CHIP0.0047μF	10% 50V
C516	1-126-935-11	ELECT	470μF 20% 16V	C575	1-163-021-91	CERAMIC CHIP0.01μF	10% 50V
C517	1-163-021-91	CERAMIC CHIP	0.01μF 10% 50V	C577	1-126-964-11	ELECT 10μF	20% 50V
C518	1-137-194-81	FILM	0.47μF 5% 50V	C701	1-128-560-11	ELECT 22μF	20% 100V
C519	1-163-021-91	CERAMIC CHIP	0.01μF 10% 50V	C702	1-128-562-11	ELECT 47μF	20% 100V
C520	1-107-914-11	ELECT	1000μF 20% 25V	C703	1-104-331-11	CERAMIC 0.0022μF	10% 1KV
C521	1-117-666-11	FILM	0.39μF 5% 250V	C704	1-104-568-11	CERAMIC 470pF	10% 2KV
C522	1-137-368-11	FILM	0.0047μF 5% 50V	C706	1-164-004-11	CERAMIC CHIP0.1μF	10% 25V
C523	1-137-368-11	FILM	0.0047μF 5% 50V	C707	1-130-495-00	FILM 0.1μF	5% 50V
C524	1-163-133-00	CERAMIC CHIP	470pF 5% 50V	C708	1-126-942-61	ELECT 1000μF	20% 25V
C525	1-104-760-11	CERAMIC CHIP	0.047μF 10% 50V	C709	1-163-021-91	CERAMIC CHIP0.01μF	10% 50V
C526	1-163-021-91	CERAMIC CHIP	0.01μF 10% 50V	C710	1-107-894-11	ELECT 220μF	20% 35V
C527	1-163-021-91	CERAMIC CHIP	0.01μF 10% 50V	C711	1-163-019-00	CERAMIC CHIP0.0068μF	10% 50V
C528	1-117-663-11	FILM	0.22μF 5% 250V	C712	1-106-228-00	MYLAR 0.22μF	10% 100V
C529	1-104-665-11	ELECT	100μF 20% 25V	C713	1-126-942-61	ELECT 1000μF	20% 25V
C530	1-163-021-91	CERAMIC CHIP	0.01μF 10% 50V	C715	1-164-004-11	CERAMIC CHIP0.1μF	10% 25V
C531	1-107-846-11	FILM	0.1μF 5% 250V	C720	1-126-964-11	ELECT 10μF	20% 50V
C532	1-163-009-11	CERAMIC CHIP	0.001μF 10% 50V	C901	1-163-021-91	CERAMIC CHIP0.01μF	10% 50V
C533	1-107-889-11	ELECT	220μF 20% 25V	C902	1-104-665-11	ELECT 100μF	20% 25V
C534	1-107-889-11	ELECT	220μF 20% 25V	C903	1-126-964-11	ELECT 10μF	20% 50V
C535	1-163-021-91	CERAMIC CHIP	0.01μF 10% 50V	C905	1-163-127-00	CERAMIC CHIP270pF	5% 50V
C536	1-126-967-11	ELECT	47μF 20% 50V	C907	1-163-257-11	CERAMIC CHIP180pF	5% 50V
C537	1-113-694-11	FILM	0.056μF 5% 400V	C908	1-163-021-91	CERAMIC CHIP0.01μF	10% 50V
C538	1-163-021-91	CERAMIC CHIP	0.01μF 10% 50V	C909	1-126-935-11	ELECT 470μF	20% 16V
C539	1-163-017-00	CERAMIC CHIP	0.0047μF 10% 50V	C910	1-126-962-11	ELECT 3.3μF	20% 50V
C540	1-106-343-00	MYLAR	0.001μF 10% 200V	C912	1-106-383-00	MYLAR 0.047μF	10% 200V
C541	1-164-161-11	CERAMIC CHIP	0.0022μF 10% 50V	C913	1-119-748-11	ELECT 33μF	20% 400V
C542	1-163-021-91	CERAMIC CHIP	0.01μF 10% 50V	C914	1-106-383-00	MYLAR 0.047μF	10% 200V
C543	1-135-350-11	FILM	3600pF 3% 1.8KV	C915	1-136-169-00	FILM 0.22μF	5% 50V
C544	1-125-925-11	FILM MELF	0.027μF 5% 400V	C916	1-117-626-11	FILM 2000pF	3% 1.2KV
C545	1-107-597-11	CERAMIC	22pF 5% 500V	C917	1-117-665-11	FILM 0.33μF	5% 250V
C546	1-107-444-11	CERAMIC	100pF 5% 2KV	C918	1-106-359-00	MYLAR 0.0047μF	10% 100V
C547	1-130-061-91	FILM	0.0015μF 5% 630V	C919	1-115-350-51	CERAMIC 0.0047μF	2KV
C548	1-162-134-11	CERAMIC	470pF 10% 2KV	C920	1-137-372-11	FILM 0.022μF	5% 50V
C549	1-130-495-00	FILM	0.1μF 5% 50V	C921	1-106-228-00	MYLAR 0.22μF	10% 100V
C550	1-127-833-11	FILM	0.15μF 5% 400V	C922	1-106-220-00	MYLAR 0.1μF	10% 100V
C551	1-163-017-00	CERAMIC CHIP	0.0047μF 10% 50V	C923	1-106-355-12	MYLAR 0.0033μF	10% 200V
C552	1-163-021-91	CERAMIC CHIP	0.01μF 10% 50V	C924	1-106-220-00	MYLAR 0.1μF	10% 100V
C554	1-107-444-11	CERAMIC	100pF 5% 2KV	C925	1-126-967-11	ELECT 47μF	20% 50V
C555	1-107-683-11	ELECT	2.2μF 250V	C926	1-126-964-11	ELECT 10μF	20% 50V
C556	1-115-356-11	FILM	1.2μF 5% 250V	C927	1-163-243-11	CERAMIC CHIP47pF	5% 50V
C557	1-163-021-91	CERAMIC CHIP	0.01μF 10% 50V	C928	1-163-133-00	CERAMIC CHIP470pF	5% 50V
C558	1-104-665-11	ELECT	100μF 20% 25V	C929	1-164-004-11	CERAMIC CHIP0.1μF	10% 25V
C559	1-107-649-11	ELECT	2.2μF 20% 250V	C930	1-163-227-11	CERAMIC CHIP10pF	0.5pF 50V
C560	1-163-021-91	ELECT	0.01μF 10% 50V	C931	1-126-964-11	ELECT 10μF	20% 50V
C561	1-104-664-11	ELECT	47μF 20% 25V	C932	1-163-021-91	CERAMIC CHIP0.01μF	10% 50V
C562	1-163-021-91	CERAMIC CHIP	0.01μF 10% 50V	C933	1-126-960-11	ELECT 1μF	20% 50V
C563	1-163-011-11	CERAMIC CHIP	0.0015μF 10% 50V	C935	1-163-275-11	CERAMIC CHIP0.001μF	5% 50V
C564	1-126-960-11	ELECT	1μF 20% 50V				

CPD-E500/E500E



REF.NO.	PART NO.	DESCRIPTION	REMARK	REF.NO.	PART NO.	DESCRIPTION	REMARK
		<CONNECTOR>		D923	8-719-988-61	DIODE 1SS355TE-17	
CN501*	1-564-509-11	PLUG, CONNECTOR 6P				<FERRITE BEAD>	
CN502*	1-564-510-11	PLUG, CONNECTOR 7P					
CN503*	1-508-879-11	BASE POST					
CN504	1-784-786-11	CONNECTOR, FFC 25P		FB501	1-410-397-21	FERRITE	1.1μH
CN505	1-784-786-11	CONNECTOR, FFC 25P		FB502	1-410-397-21	FERRITE	1.1μH
				FB503	1-412-911-11	FERRITE	1.1μH
CN506	1-764-101-11	PIN, CONNECTOR (PC BOARD) 2P		FB504	1-412-911-11	FERRITE	1.1μH
CN508*	1-564-511-11	PLUG, CONNECTOR 8P		FB505	1-412-911-11	FERRITE	1.1μH
CN509*	1-778-955-11	PIN, CONNECTOR (PC BOARD) 10P					
		<DIODE>		FB506	1-410-397-21	FERRITE	1.1μH
D504	8-719-988-61	DIODE 1SS355TE-17		FB507	1-410-397-21	FERRITE	1.1μH
D505	8-719-110-36	ZENER DIODE RD13ESB2		FB901	1-410-397-21	FERRITE	1.1μH
D506	8-719-991-33	DIODE 1SS133T-77				<IC>	
D507	8-719-063-89	DIODE YG911S3R		IC501	8-759-585-82	IC BA9759F-E2	
D508	8-719-031-79	DIODE D5SC4M		IC502	8-759-803-42	IC LA6500-FA	
				IC503	8-759-058-50	IC XRA10324AF	
D509	8-719-991-33	DIODE 1SS133T-77		IC701	8-759-444-82	IC LA7841L	
D510	8-719-109-85	ZENER DIODE RD5.1ESB2		IC901	8-759-585-81	IC BA9758FS-E2	
D511	8-719-066-36	DIODE FMQ-G5GS				<CHIP CONDUCTOR>	
D512	8-719-988-61	DIODE 1SS355TE-17		JR002	1-216-296-91	SHORT	0
D513	8-719-991-33	DIODE 1SS133T-77		JR003	1-216-295-91	SHORT	0
				JR004	1-216-295-91	SHORT	0
D514	8-719-991-33	DIODE 1SS133T-77		JR005	1-216-296-91	SHORT	0
D515	8-719-109-89	ZENER DIODE RD5.6ESB2		JR006	1-216-295-91	SHORT	0
D516	8-719-991-33	DIODE 1SS133T-77					
D517	8-719-951-30	DIODE ERA91-02		JR008	1-216-295-91	SHORT	0
D519	8-719-988-61	DIODE 1SS355TE-17		JR009	1-216-295-91	SHORT	0
				JR010	1-216-295-91	SHORT	0
D520	8-719-988-61	DIODE 1SS355TE-17		JR011	1-216-295-91	SHORT	0
D522	8-719-988-61	DIODE 1SS355TE-17		JR012	1-216-296-91	SHORT	0
D701	8-719-991-33	DIODE 1SS133T-77					
D702	8-719-991-33	DIODE 1SS133T-77		JR013	1-216-295-91	SHORT	0
D703	8-719-991-33	DIODE 1SS133T-77		JR014	1-216-296-91	SHORT	0
				JR015	1-216-296-91	SHORT	0
D706	8-719-979-58	DIODE EGP10D		JR016	1-216-295-91	SHORT	0
D707	8-719-109-85	ZENER DIODE RD5.1ESB2				<COIL>	
D708	8-719-908-03	DIODE GP08D		L501	1-412-537-31	INDUCTOR	100μH
D709	8-719-948-45	DIODE ERA22-08		L502	1-406-673-11	COIL, CHOKE	2.2mH
D710	8-719-109-85	ZENER DIODE RD5.1ESB2		L503	1-406-671-11	COIL, CHOKE	1mH
				L504	1-406-675-11	COIL, CHOKE	4.7mH
D901	8-719-991-33	DIODE 1SS133T-77		L505	1-416-401-31	COIL, CHOKE	5mH
D902	8-719-110-31	ZENER DIODE RD12ESB2					
D904	8-719-988-61	DIODE 1SS355TE-17		L901	1-412-537-31	INDUCTOR	100μH
D905	8-719-110-36	ZENER DIODE RD13ESB2		L902	1-406-660-41	COIL, CHOKE	15μH
D906	8-719-063-89	DIODE YG911S3R				<TRANSISTOR>	
D907	8-719-930-97	ZENER DIODE HZS16NB2TD		Q501	8-729-048-49	TRANSISTOR 2SK3262-01MR-F119	
D908	8-719-018-82	DIODE RGP02-20EL-6394		Q502	8-729-120-28	TRANSISTOR 2SC1623-L5L6	
D909	8-719-930-97	ZENER DIODE HZS16NB2TD		Q503	8-729-901-97	TRANSISTOR 2SA1036K-Q	
D910	8-719-991-33	DIODE 1SS133T-77		Q504	8-729-901-87	TRANSISTOR 2SC2411K-CQ	
D912	8-719-979-58	DIODE EGP10D		Q505	8-729-901-97	TRANSISTOR 2SA1036K-Q	
D913	8-719-991-33	DIODE 1SS133T-77		Q506	8-729-048-49	TRANSISTOR 2SK3262-01MR-F119	
D914	8-719-991-33	DIODE 1SS133T-77		Q507	8-729-048-49	TRANSISTOR 2SK3262-01MR-F119	
D915	8-719-929-72	ZENER DIODE HZS33NB2					
D917	8-719-988-61	DIODE 1SS355TE-17					
D918	8-719-991-33	DIODE 1SS133T-77					
D919	8-719-991-33	DIODE 1SS133T-77					
D920	8-719-928-85	ZENER DIODE HZS4.7NB2					
D921	8-719-988-61	DIODE 1SS355TE-17					
D922	8-719-018-82	DIODE RGP02-20EL-6394					



REF.NO.	PART NO.	DESCRIPTION	REMARK	REF.NO.	PART NO.	DESCRIPTION	REMARK
Q508	8-729-048-53	TRANSISTOR 2SJ569LS-CB11		R522	1-249-437-11	CARBON 47K	5% 1/4W
Q509	8-729-820-73	TRANSISTOR 2SC3746		R523	1-216-033-00	RES,CHIP 220	5% 1/10W
Q510	8-729-048-49	TRANSISTOR 2SK3262-01MR-F119		R524	1-216-049-91	RES,CHIP 1K	5% 1/10W
				R525	1-216-065-91	RES,CHIP 4.7K	5% 1/10W
Q511	8-729-048-49	TRANSISTOR 2SK3262-01MR-F119		R526	1-216-097-91	RES,CHIP 100K	5% 1/10W
Q512	8-729-048-49	TRANSISTOR 2SK3262-01MR-F119		R527	1-216-673-11	METAL CHIP 8.2K	0.5% 1/10W
Q513	8-729-048-49	TRANSISTOR 2SK3262-01MR-F119		R528	1-216-677-11	METAL CHIP 12K	0.5% 1/10W
Q514	8-729-140-50	TRANSISTOR 2SC3209LK		R529	1-216-057-00	RES,CHIP 2.2K	5% 1/10W
Q515	8-729-048-48	TRANSISTOR 2SC5570 (LBSONY)		R530	1-216-049-91	RES,CHIP 1K	5% 1/10W
Q516	8-729-024-95	TRANSISTOR 2SB1565EF		R531	1-216-097-91	RES,CHIP 100K	5% 1/10W
Q517	8-729-048-49	TRANSISTOR 2SK3262-01MR-F119		R532	1-215-860-11	METAL OXIDE 33	5% 1W F
Q518	8-729-019-01	TRANSISTOR 2SD2394-EF		R533	1-211-796-11	FUSIBLE 1	5% 1/2W F
Q519	8-729-033-25	TRANSISTOR DTC114GKA		R534	1-216-689-11	METAL CHIP 39K	0.5% 1/10W
Q520	8-729-120-28	TRANSISTOR 2SC1623-L5L6		R535	1-216-065-91	RES,CHIP 4.7K	5% 1/10W
Q521	8-729-120-28	TRANSISTOR 2SC1623-L5L6		R536	1-216-683-11	METAL CHIP 22K	0.5% 1/10W
Q522	8-729-120-28	TRANSISTOR 2SC1623-L5L6		R537	1-249-437-11	CARBON 47K	5% 1/4W
Q523	8-729-120-28	TRANSISTOR 2SC1623-L5L6		R538	1-216-049-91	RES,CHIP 1K	5% 1/10W
Q524	8-729-026-49	TRANSISTOR 2SA1037AK-T146-R		R539	1-216-097-91	RES,CHIP 100K	5% 1/10W
Q525	8-729-048-49	TRANSISTOR 2SK3262-01MR-F119		R540	1-215-909-11	METAL OXIDE 47	5% 3W F
Q526	8-729-027-35	TRANSISTOR DTA143TKA-T146		R541	1-216-295-91	SHORT 0	
Q701	8-729-800-32	TRANSISTOR 2SC2362K-G		R542	1-249-437-11	CARBON 47K	5% 1/4W
Q702	8-729-178-43	TRANSISTOR 2SC2784-E		R543	1-216-677-11	METAL CHIP 12K	0.5% 1/10W
Q703	8-729-204-91	TRANSISTOR 2SA1049-GR		R544	1-216-049-91	RES,CHIP 1K	5% 1/10W
Q704	8-729-207-82	TRANSISTOR 2SC3421-Y		R545	1-216-097-91	RES,CHIP 100K	5% 1/10W
Q705	8-729-207-89	TRANSISTOR 2SA1358-Y		R546	1-216-381-11	METAL OXIDE 0.22	5% 3W F
Q706	8-729-026-49	TRANSISTOR 2SA1037AK-T146-R		R547	1-219-726-11	METAL 2.2	5% 10W
Q707	8-729-046-80	TRANSISTOR 2SC4634LS-CB11		R548	1-249-437-11	CARBON 47K	5% 1/4W
Q903	8-729-901-87	TRANSISTOR 2SC2411K-CQ		R549	1-260-288-11	CARBON 0.47	5% 1/2W
Q904	8-729-901-97	TRANSISTOR 2SA1036K-Q		R550	1-260-288-11	CARBON 0.47	5% 1/2W
Q905	8-729-048-53	TRANSISTOR 2SJ569LS-CB11		R551	1-216-049-91	RES,CHIP 1K	5% 1/10W
Q906	8-729-044-21	TRANSISTOR 2SK2655-01R-F165		R552	1-216-097-91	RES,CHIP 100K	5% 1/10W
Q907	8-729-033-26	TRANSISTOR DTA114GKAT146		R553	1-247-815-91	CARBON 220	5% 1/4W
Q908	8-729-033-25	TRANSISTOR DTC114GKA		R554	1-216-679-11	METAL CHIP 15K	0.5% 1/10W
		<RESISTOR>		R555	1-216-675-91	METAL CHIP 10K	0.5% 1/10W
R501	1-215-884-11	METAL OXIDE 47	5% 2W F	R556	1-216-683-11	METAL CHIP 22K	0.5% 1/10W
R502	1-216-059-00	RES,CHIP 2.7K	5% 1/10W	R557	1-216-423-11	METAL OXIDE 27	5% 1W F
R503	1-216-049-91	RES,CHIP 1K	5% 1/10W	R558	1-249-437-11	CARBON 47K	5% 1/4W
R504	1-216-049-91	RES,CHIP 1K	5% 1/10W	R559	1-216-073-00	RES,CHIP 10K	5% 1/10W
R505	1-216-049-91	RES,CHIP 1K	5% 1/10W	R560	1-216-675-91	METAL CHIP 10K	0.5% 1/10W
R506	1-216-049-91	RES,CHIP 1K	5% 1/10W	R561	1-215-443-00	METAL 8.2K	1% 1/4W
R507	1-216-097-91	RES,CHIP 100K	5% 1/10W	R562	1-216-677-11	METAL CHIP 12K	0.5% 1/10W
R508	1-247-815-91	CARBON 220	5% 1/4W	R563	1-216-049-91	RES,CHIP 1K	5% 1/10W
R509	1-216-049-91	RES,CHIP 1K	5% 1/10W	R564	1-216-677-11	METAL CHIP 12K	0.5% 1/10W
R510	1-216-675-91	METAL CHIP 10K	0.5% 1/10W	R565	1-216-097-91	RES,CHIP 100K	5% 1/10W
R511	1-216-065-91	RES,CHIP 4.7K	5% 1/10W	R566	1-216-687-11	METAL CHIP 33K	0.5% 1/10W
R512	1-215-453-00	METAL 22K	1% 1/4W	R567	1-214-840-00	METAL 100	1% 1/2W
R513	1-216-049-91	RES,CHIP 1K	5% 1/10W	R568	1-216-665-11	METAL CHIP 3.9K	0.5% 1/10W
R514	1-216-097-91	RES,CHIP 100K	5% 1/10W	R569	1-216-691-11	METAL CHIP 47K	0.5% 1/10W
R515	1-216-049-91	RES,CHIP 1K	5% 1/10W	R570	1-260-332-51	CARBON 2.2K	5% 1/2W
R516	1-216-049-91	RES,CHIP 1K	5% 1/10W	R571	1-249-425-11	CARBON 4.7K	5% 1/4W
R517	1-216-687-11	METAL CHIP 33K	0.5% 1/10W	R572	1-216-385-11	METAL OXIDE 0.47	5% 3W F
R518	1-216-691-11	METAL CHIP 47K	0.5% 1/10W	R573	1-249-437-11	CARBON 47K	5% 1/4W
R519	1-216-081-00	RES,CHIP 22K	5% 1/10W	R574	1-216-097-91	RES,CHIP 100K	5% 1/10W
R520	1-247-791-91	CARBON 22	5% 1/4W	R575	1-216-672-11	METAL CHIP 7.5K	0.5% 1/10W
R521	1-216-667-11	METAL CHIP 4.7K	0.5% 1/10W	R576	1-215-869-11	METAL OXIDE 1K	5% 1W F
				R577	1-260-310-71	CARBON 33	5% 1/2W

The components identified Δ marked are critical for safety.
Replace only with the part number specified.

Les composants identifiés par la marque Δ sont critiques pour la sécurité.
Ne les remplacer que par une pièce portant le numéro spécifié.



REF.NO.	PART NO.	DESCRIPTION	REMARK	REF.NO.	PART NO.	DESCRIPTION	REMARK
		<SPARK GAP>		R804	1-247-815-91	CARBON 220	5% 1/4W
				R811	1-249-429-11	CARBON 10K	5% 1/4W
SG901	1-517-499-21	GAP, SPARK		R812	1-249-429-11	CARBON 10K	5% 1/4W
SG902	1-519-422-11	GAP, SPARK		R813	1-247-863-91	CARBON 22K	5% 1/4W
SG903	1-519-422-11	GAP, SPARK		R814	1-249-441-11	CARBON 100K	5% 1/4W
		<TRANSFORMER>		R815	1-215-445-00	METAL 10K	1% 1/4W
				R821	1-215-401-11	METAL 150	1% 1/4W
T501	1-435-070-11	TRANSFORMER, HORIZONTAL DRIVE		R822	1-215-413-00	METAL 470	1% 1/4W
T502	1-429-301-11	TRANSFORMER, FERRITE (HCT)		R823	1-215-421-00	METAL 1K	1% 1/4W
T503	1-431-413-21	TRANSFORMER, FERRITE (HST)		R824	1-215-425-00	METAL 1.5K	1% 1/4W
T505	1-419-127-11	COIL, HORIZONTAL LINEARITY		R851	1-249-413-11	CARBON 470	5% 1/4W
T701	1-431-414-11	TRANSFORMER, FERRITE (DFT)		R852	1-247-807-31	CARBON 100	5% 1/4W
T901	1-416-402-11	INDUCTOR 500 μ H		R853	1-247-807-31	CARBON 100	5% 1/4W
T902	Δ X-4560-175-1	TRANSFORMER ASSY, FLYBACK (NX-4502//J1D4)				<SWITCH>	
		<THERMISTOR>		S801	1-771-734-11	SWITCH, TACTILE (MENU)	
TH501	1-807-796-11	THERMISTOR		S812	1-554-303-21	SWITCH, KEY BOARD (RESET)	
TH502	1-807-796-11	THERMISTOR				<THERMISTOR>	
*****				TH801	1-807-796-11	THERMISTOR	
		* A-1372-770-A H1 BOARD, COMPLETE [U/C for Mexico-made set]		*****			
		* A-1372-799-A H1 BOARD, COMPLETE [U/C for Japan-made set]				* A-1388-250-B J BOARD, COMPLETE [U/C for Japan-made set]	
		* A-1646-206-A H1 BOARD, COMPLETE [AEP] *****				* A-1388-260-B J BOARD, COMPLETE [AEP]	
						* A-1388-261-B J BOARD, COMPLETE [U/C for Mexico-made set] *****	
		<CAPACITOR>				<CONNECTOR>	
C802	1-126-791-11	ELECT 10 μ F	20% 16V			CN891*1-691-960-11	PIN, CONNECTOR (PC BOARD) 3P
C806	1-126-786-11	ELECT 47 μ F	20% 16V				<SWITCH>
		<CONNECTOR>				S891 Δ 1-571-433-31	SWITCH, PUSH (AC POWER)
CN801*	1-564-526-11	PLUG, CONNECTOR 11P		*****			
		<DIODE>				* A-1394-950-B N BOARD, COMPLETE [AEP]	
D801	8-719-064-11	DIODE SPR-325MVW (POWER)				* A-1394-973-A N BOARD, COMPLETE [U/C for Mexico-made set]	
		<TRANSISTOR>				* A-1394-984-A N BOARD, COMPLETE [U/C for Japan-made set] *****	
Q801	8-729-119-78	TRANSISTOR 2SC2785-HFE				<CAPACITOR>	
Q802	8-729-119-78	TRANSISTOR 2SC2785-HFE		C001	1-163-009-11	CERAMIC CHIP 0.001 μ F	10% 50V
Q803	8-729-029-40	TRANSISTOR DTA124ESA		C002	1-163-009-11	CERAMIC CHIP 0.001 μ F	10% 50V
Q804	8-729-029-40	TRANSISTOR DTA124ESA					
		<RESISTOR>					
R801	1-249-417-11	CARBON 1K	5% 1/4W				
R802	1-249-413-11	CARBON 470	5% 1/4W				
R803	1-247-815-91	CARBON 220	5% 1/4W				

CPD-E500/E500E



REF.NO.	PART NO.	DESCRIPTION	REMARK	REF.NO.	PART NO.	DESCRIPTION	REMARK
C003	1-163-021-91	CERAMIC CHIP0.01μF	10% 50V	C061	1-163-021-91	CERAMIC CHIP0.01μF	10% 50V
C005	1-163-255-11	CERAMIC CHIP 150pF	5% 50V	C062	1-126-925-11	ELECT 470μF	20% 10V
C006	1-163-235-11	CERAMIC CHIP 22pF	5% 50V	C063	1-164-690-91	CERAMIC CHIP 0.0022μF	5% 50V
C007	1-163-235-11	CERAMIC CHIP 22pF	5% 50V	C064	1-115-419-11	CERAMIC CHIP 3300pF	5% 25V
C008	1-164-004-11	CERAMIC CHIP 0.1μF	10% 25V	C065	1-126-960-11	ELECT 1μF	20% 50V
C009	1-115-339-11	CERAMIC CHIP 0.1μF	10% 50V	C066	1-164-690-91	CERAMIC CHIP 0.0022μF	5% 50V
C010	1-126-967-11	ELECT 47μF	20% 50V	C067	1-164-004-11	CERAMIC CHIP 0.1μF	10% 25V
C011	1-115-339-11	CERAMIC CHIP 0.1μF	10% 50V	C068	1-136-169-00	FILM 0.22μF	5% 50V
C012	1-126-967-11	ELECT 47μF	20% 50V	C069	1-115-339-11	CERAMIC CHIP 0.1μF	10% 50V
C013	1-126-965-11	ELECT 22μF	20% 50V	C070	1-126-767-11	ELECT 1000μF	20% 16V
C014	1-163-021-91	CERAMIC CHIP 0.01μF	10% 50V	C071	1-163-007-11	CERAMIC CHIP 680pF	10% 50V
C015	1-163-021-91	CERAMIC CHIP 0.01μF	10% 50V	C072	1-126-942-61	ELECT 1000μF	20% 25V
C016	1-163-021-91	CERAMIC CHIP 0.01μF	10% 50V	C073	1-115-339-11	CERAMIC CHIP 0.1μF	10% 50V
C017	1-163-021-91	CERAMIC CHIP 0.01μF	10% 50V	C074	1-163-137-00	CERAMIC CHIP 680pF	5% 50V
C018	1-163-021-91	CERAMIC CHIP 0.01μF	10% 50V	C075	1-163-251-11	CERAMIC CHIP 100pF	5% 50V
C019	1-163-021-91	CERAMIC CHIP 0.01μF	10% 50V	C077	1-115-339-11	CERAMIC CHIP 0.1μF	10% 50V
C020	1-163-021-91	CERAMIC CHIP 0.01μF	10% 50V	C078	1-136-169-00	FILM 0.22μF	5% 50V
C021	1-163-021-91	CERAMIC CHIP 0.01μF	10% 50V	C079	1-163-021-91	CERAMIC CHIP 0.01μF	10% 50V
C022	1-163-021-91	CERAMIC CHIP 0.01μF	10% 50V	C080	1-126-967-11	ELECT 47μF	20% 50V
C023	1-163-021-91	CERAMIC CHIP 0.01μF	10% 50V	C082	1-104-664-11	ELECT 47μF	20% 25V
C024	1-164-161-11	CERAMIC CHIP 2200PF	10% 50V	C083	1-163-021-91	CERAMIC CHIP 0.01μF	10% 50V
C025	1-163-009-11	CERAMIC CHIP 0.001μF	10% 50V	C084	1-126-964-11	ELECT 10μF	20% 50V
C026	1-104-665-11	ELECT 100μF	20% 25V	C085	1-163-021-91	CERAMIC CHIP 0.01μF	10% 50V
C027	1-115-339-11	CERAMIC CHIP 0.1μF	10% 50V	C086	1-163-021-91	CERAMIC CHIP 0.01μF	10% 50V
C028	1-163-220-11	CERAMIC CHIP 3pF	0.25pF 50V	C087	1-126-964-11	ELECT 10μF	20% 50V
C029	1-163-241-11	CERAMIC CHIP 39pF	5% 50V	C089	1-163-021-91	CERAMIC CHIP 0.01μF	10% 50V
C031	1-126-964-11	ELECT 10μF	20% 50V	C090	1-163-021-91	CERAMIC CHIP 0.01μF	10% 50V
C033	1-163-021-91	CERAMIC CHIP 0.01μF	10% 50V	C091	1-126-933-11	ELECT 100μF	20% 16V
C036	1-163-037-11	CERAMIC CHIP 0.022μF	10% 50V	C094	1-164-004-11	CERAMIC CHIP 0.1μF	10% 25V
C037	1-126-964-11	ELECT 10μF	20% 50V	C095	1-117-722-11	ELECT 2200μF	20% 10V
C038	1-126-964-11	ELECT 10μF	20% 50V	C096	1-163-021-91	CERAMIC CHIP 0.01μF	10% 50V
C039	1-126-964-11	ELECT 10μF	20% 50V	C097	1-126-964-11	ELECT 10μF	20% 50V
C040	1-126-964-11	ELECT 10μF	20% 50V	C098	1-163-021-91	CERAMIC CHIP 0.01μF	10% 50V
C041	1-126-964-11	ELECT 10μF	20% 50V	C099	1-164-004-11	CERAMIC CHIP 0.1μF	10% 25V
C042	1-163-021-91	CERAMIC CHIP 0.01μF	10% 50V	C1003	1-104-664-11	ELECT 47μF	20% 25V
C043	1-126-965-11	ELECT 22μF	20% 50V	C1004	1-163-021-91	CERAMIC CHIP 0.01μF	10% 50V
C044	1-163-037-11	CERAMIC CHIP 0.022μF	10% 50V	C1005	1-163-005-11	CERAMIC CHIP 470pF	10% 50V
C045	1-163-037-11	CERAMIC CHIP 0.022μF	10% 50V	C1006	1-164-161-11	CERAMIC CHIP 0.0022μF	10% 50V
C046	1-163-037-11	CERAMIC CHIP 0.022μF	10% 50V	C1007	1-115-339-11	CERAMIC CHIP 0.1μF	10% 50V
C047	1-163-037-11	CERAMIC CHIP 0.022μF	10% 50V	C5002	1-126-964-11	ELECT 10μF	20% 50V
C048	1-163-021-91	CERAMIC CHIP 0.01μF	10% 50V	C5003	1-126-933-11	ELECT 100μF	20% 16V
C049	1-126-964-11	ELECT 10μF	20% 50V	C5004	1-104-664-11	ELECT 47μF	20% 25V
C050	1-126-964-11	ELECT 10μF	20% 50V	C5005	1-104-664-11	ELECT 47μF	20% 25V
C051	1-163-021-91	CERAMIC CHIP 0.01μF	10% 50V	C5008	1-104-664-11	ELECT 47μF	20% 25V
C052	1-126-933-11	ELECT 100μF	20% 16V	C5009	1-164-004-11	CERAMIC CHIP 0.1μF	10% 25V
C053	1-163-021-91	CERAMIC CHIP 0.01μF	10% 50V	C5101	1-164-004-11	CERAMIC CHIP 0.1μF	10% 25V
C054	1-115-339-11	CERAMIC CHIP 0.1μF	10% 50V	C5103	1-164-004-11	CERAMIC CHIP 0.1μF	10% 25V
C055	1-104-664-11	ELECT 47μF	20% 25V	C5106	1-164-004-11	CERAMIC CHIP 0.1μF	10% 25V
C056	1-126-965-11	ELECT 22μF	20% 50V	C5108	1-164-004-11	CERAMIC CHIP 0.1μF	10% 25V
C057	1-126-964-11	ELECT 10μF	20% 50V	C5110	1-104-664-11	ELECT 47μF	20% 25V
C058	1-164-690-91	CERAMIC CHIP 0.0022μF	5% 50V	C5203	1-164-004-11	CERAMIC CHIP 0.1μF	10% 25V
C059	1-126-964-11	ELECT 10μF	20% 50V	C5205	1-164-004-11	CERAMIC CHIP 0.1μF	10% 25V
				C5206	1-163-021-91	CERAMIC CHIP 0.01μF	10% 50V
				C5301	1-164-004-11	CERAMIC CHIP 0.1μF	10% 25V
				C5303	1-164-004-11	CERAMIC CHIP 0.1μF	10% 25V



REF.NO.	PART NO.	DESCRIPTION	REMARK	REF.NO.	PART NO.	DESCRIPTION	REMARK
C5304	1-163-021-91	CERAMIC CHIP0.01μF	10% 50V	D027	8-719-988-61	DIODE 1SS355TE-17	
C5305	1-104-664-11	ELECT 47μF	20% 25V	D028	8-719-988-61	DIODE 1SS355TE-17	
C5306	1-164-004-11	CERAMIC CHIP0.1μF	10% 25V	D029	8-719-109-85	ZENER DIODE RD5.1ESB2	
C5308	1-164-004-11	CERAMIC CHIP0.1μF	10% 25V	D036	8-719-109-89	ZENER DIODE RD5.6ESB2	
C5310	1-104-664-11	ELECT 47μF	20% 25V	D038	8-719-045-99	ZENER DIODE RD2.2M-T1B	
C5401	1-164-004-11	CERAMIC CHIP0.1μF	10% 25V	D040	8-719-109-89	ZENER DIODE RD5.6ESB2	
C5403	1-163-021-91	CERAMIC CHIP0.01μF	10% 50V			<FERRITE BEAD>	
C5404	1-163-021-91	CERAMIC CHIP0.01μF	10% 50V	FB001	1-410-397-21	FERRITE 1.1μH	
C5406	1-164-004-11	CERAMIC CHIP0.1μF	10% 25V	FB002	1-410-397-21	FERRITE 1.1μH	
C5408	1-163-005-11	CERAMIC CHIP470pF	10% 50V	FB003	1-410-397-21	FERRITE 1.1μH	
C5409	1-163-021-91	CERAMIC CHIP0.01μF	10% 50V	FB5101	1-412-911-11	FERRITE 1.1μH	
C5413	1-164-004-11	CERAMIC CHIP0.1μF	10% 25V	FB5103	1-412-911-11	FERRITE 1.1μH	
C5501	1-126-967-11	ELECT 47μF	20% 50V	FB5201	1-412-911-11	FERRITE 1.1μH	
C5602	1-115-339-11	CERAMIC CHIP0.1μF	10% 50V	FB5301	1-412-911-11	FERRITE 1.1μH	
C5606	1-163-021-91	CERAMIC CHIP0.01μF	10% 50V	FB5303	1-412-911-11	FERRITE 1.1μH	
C5607	1-164-004-11	CERAMIC CHIP0.1μF	10% 25V	FB5401	1-412-911-11	FERRITE 1.1μH	
		<CONNECTOR>		FB5403	1-412-911-11	FERRITE 1.1μH	
CN001	1-784-500-11	CONNECTOR, FFC/FPC 21P		FB5601	1-412-911-11	FERRITE 1.1μH	
CN002*	1-564-511-11	PLUG, CONNECTOR 8P				<SENSOR>	
CN007*	1-564-512-11	PLUG, CONNECTOR 9P		GS5001	1-418-473-11	SENSOR UNIT, GEOMAGNETIC	
CN010	1-784-786-11	CONNECTOR, FFC 25P				<IC>	
CN011	1-784-786-11	CONNECTOR, FFC 25P		IC001	8-759-658-88	IC CXD8744Q-0007	
CN5001*	1-564-509-11	PLUG, CONNECTOR 6P		IC002	8-759-162-80	IC MM1170BFB	
CN5002*	1-564-511-11	PLUG, CONNECTOR 8P		IC003	8-759-527-77	IC M24C16-MN6T	
CN5003*	1-564-505-11	PLUG, CONNECTOR 2P		IC004	8-759-639-81	IC SN74AHCT74PWR [AEP]	
		<DIODE>		IC005	8-759-639-81	IC SN74AHCT74PWR	
D001	8-719-062-51	DIODE 1PS226-115		IC006	8-759-700-78	NJM082M	
D002	8-719-062-51	DIODE 1PS226-115		IC010	8-759-585-70	IC LA7865M-TLM	
D003	8-719-109-89	DIODE 1PS226-115 [AEP]		IC011	8-759-442-20	IC 24LC21AT/SN [AEP]	
D004	8-719-109-89	DIODE 1PS226-115 [AEP]		IC012	8-759-442-20	IC 24LC21AT/SN [U/C]	
D005	8-719-109-89	ZENER DIODE RD5.6ESB2 [U/C]		IC5101	8-759-822-07	IC LA6515	
D006	8-719-109-89	ZENER DIODE RD5.6ESB2 [U/C]		IC5201	8-759-822-07	IC LA6515	
D007	8-719-109-89	ZENER DIODE RD5.6ESB2 [U/C]		IC5301	8-759-822-07	IC LA6515	
D008	8-719-109-89	ZENER DIODE RD5.6ESB2 [AEP]		IC5401	8-759-822-07	IC LA6515	
D009	8-719-109-89	ZENER DIODE RD5.6ESB2 [AEP]				<COIL>	
D010	8-719-109-89	ZENER DIODE RD5.6ESB2 [AEP]		L002	1-406-665-11	COIL, CHOKE 100μH	
D011	8-719-109-89	ZENER DIODE RD5.6ESB2 [U/C]		L003	1-406-671-11	COIL, CHOKE 1mH	
D012	8-719-109-89	ZENER DIODE RD5.6ESB2 [AEP]				<TRANSISTOR>	
D013	8-719-110-17	ZENER DIODE RD10ESB2		Q001	8-729-026-49	TRANSISTOR 2SA1037AK-T146-R	
D014	8-719-066-11	DIODE 1PS184-115 [U/C]		Q002	8-729-026-49	TRANSISTOR 2SA1037AK-T146-R	
D015	8-719-066-11	DIODE 1PS184-115 [AEP]		Q003	8-729-026-49	TRANSISTOR 2SA1037AK-T146-R	
D016	8-719-109-89	ZENER DIODE RD5.6ESB2		Q004	8-729-028-83	TRANSISTOR DTA124EUA-T106	
D017	8-719-109-89	ZENER DIODE RD5.6ESB2		Q005	8-729-033-26	TRANSISTOR DTA114GKAT146	
D018	8-719-109-89	ZENER DIODE RD5.6ESB2		Q006	8-729-027-49	TRANSISTOR DTC123EKA-T146	
D020	8-719-988-61	DIODE 1SS355TE-17		Q007	8-729-901-00	TRANSISTOR DTC124EK	
D021	8-719-988-61	DIODE 1SS355TE-17		Q008	8-729-033-25	TRANSISTOR DTC114GKA	
D022	8-719-066-11	DIODE 1PS184-115					
D023	8-719-066-11	DIODE 1PS184-115					
D024	8-719-066-11	DIODE 1PS184-115 [AEP]					
D025	8-719-062-51	DIODE 1PS226-115					
D026	8-719-062-51	DIODE 1PS226-115					

CPD-E500/E500E



REF.NO.	PART NO.	DESCRIPTION	REMARK	REF.NO.	PART NO.	DESCRIPTION	REMARK
Q010	8-729-026-49	TRANSISTOR 2SA1037AK-T146-R		R049	1-216-073-00	RES,CHIP 10K	5% 1/10W
Q011	8-729-026-49	TRANSISTOR 2SA1037AK-T146-R		R050	1-216-089-91	RES,CHIP 47K	5% 1/10W [U/C]
Q012	8-729-901-00	TRANSISTOR DTC124EK		R050	1-216-295-91	SHORT 0	[AEP]
	<RESISTOR>			R051	1-216-077-91	RES,CHIP 15K	5% 1/10W [U/C]
R003	1-216-025-91	RES,CHIP 100	5% 1/10W	R051	1-216-049-91	RES,CHIP 1K	5% 1/10W [AEP]
R004	1-216-025-91	RES,CHIP 100	5% 1/10W	R052	1-216-077-91	RES,CHIP 15K	5% 1/10W [U/C]
R005	1-216-025-91	RES,CHIP 100	5% 1/10W [AEP]	R052	1-216-049-91	RES,CHIP 1K	5% 1/10W [AEP]
R006	1-216-025-91	RES,CHIP 100	5% 1/10W [AEP]	R053	1-216-065-91	RES,CHIP 4.7K	5% 1/10W
R007	1-216-057-00	RES,CHIP 2.2K	5% 1/10W	R054	1-216-077-91	RES,CHIP 15K	5% 1/10W
R008	1-216-057-00	RES,CHIP 2.2K	5% 1/10W	R055	1-216-049-91	RES,CHIP 1K	5% 1/10W [U/C]
R009	1-216-057-00	RES,CHIP 2.2K	5% 1/10W	R055	1-216-077-91	RES,CHIP 15K	5% 1/10W [AEP]
R010	1-216-057-00	RES,CHIP 2.2K	5% 1/10W	R056	1-216-073-00	RES,CHIP 10K	5% 1/10W
R011	1-249-389-11	CARBON 4.7	5% 1/4W [U/C]	R057	1-216-073-00	RES,CHIP 10K	5% 1/10W
R012	1-216-017-91	RES,CHIP 47	5% 1/10W [U/C]	R058	1-216-067-00	RES,CHIP 5.6K	5% 1/10W
R013	1-216-017-91	RES,CHIP 47	5% 1/10W [U/C]	R059	1-216-057-00	RES,CHIP 2.2K	5% 1/10W
R014	1-216-049-91	RES,CHIP 1K	5% 1/10W	R060	1-216-057-00	RES,CHIP 2.2K	5% 1/10W
R015	1-249-389-11	CARBON 4.7	5% 1/4W [AEP]	R061	1-216-049-91	RES,CHIP 1K	5% 1/10W
R016	1-216-017-91	RES,CHIP 47	5% 1/10W [AEP]	R062	1-216-613-11	METAL CHIP 27	0.5% 1/10W
R017	1-216-017-91	RES,CHIP 47	5% 1/10W [AEP]	R063	1-216-613-11	METAL CHIP 27	0.5% 1/10W
R018	1-216-049-91	RES,CHIP 1K	5% 1/10W [AEP]	R064	1-216-613-11	METAL CHIP 27	0.5% 1/10W
R019	1-216-025-91	RES,CHIP 100	5% 1/10W	R066	1-216-049-91	RES,CHIP 1K	5% 1/10W
R020	1-216-025-91	RES,CHIP 100	5% 1/10W	R067	1-216-073-00	RES,CHIP 10K	5% 1/10W
R021	1-216-025-91	RES,CHIP 100	5% 1/10W	R075	1-215-407-00	METAL 270	1% 1/4W
R022	1-216-025-91	RES,CHIP 100	5% 1/10W	R076	1-215-407-00	METAL 270	1% 1/4W
R023	1-216-065-91	RES,CHIP 4.7K	5% 1/10W	R077	1-216-073-00	RES,CHIP 10K	5% 1/10W
R024	1-216-025-91	RES,CHIP 100	5% 1/10W	R078	1-216-121-91	RES,CHIP 1M	5% 1/10W
R025	1-216-025-91	RES,CHIP 100	5% 1/10W	R079	1-216-295-91	SHORT 0	
R026	1-216-025-91	RES,CHIP 100	5% 1/10W	R080	1-216-295-91	SHORT 0	
R029	1-216-073-00	RES,CHIP 10K	5% 1/10W	R081	1-216-049-91	RES,CHIP 1K	5% 1/10W
R030	1-216-049-91	RES,CHIP 1K	5% 1/10W	R082	1-216-049-91	RES,CHIP 1K	5% 1/10W
R031	1-216-669-11	METAL CHIP 5.6K	0.5% 1/10W	R084	1-216-073-00	RES,CHIP 10K	5% 1/10W
R032	1-216-665-11	METAL CHIP 3.9K	0.5% 1/10W	R085	1-216-049-91	RES,CHIP 1K	5% 1/10W
R034	1-216-049-91	RES,CHIP 1K	5% 1/10W	R086	1-216-049-91	RES,CHIP 1K	5% 1/10W
R035	1-216-065-91	RES,CHIP 4.7K	5% 1/10W	R090	1-216-073-00	RES,CHIP 10K	5% 1/10W
R036	1-216-659-11	METAL CHIP 2.2K	0.5% 1/10W	R091	1-216-049-91	RES,CHIP 1K	5% 1/10W
R037	1-216-073-00	RES,CHIP 10K	5% 1/10W	R092	1-216-049-91	RES,CHIP 1K	5% 1/10W
R039	1-216-025-91	RES,CHIP 100	5% 1/10W	R093	1-216-049-91	RES,CHIP 1K	5% 1/10W
R040	1-216-025-91	RES,CHIP 100	5% 1/10W	R094	1-216-049-91	RES,CHIP 1K	5% 1/10W
R042	1-216-073-00	RES,CHIP 10K	5% 1/10W	R095	1-216-049-91	RES,CHIP 1K	5% 1/10W
R043	1-216-049-91	RES,CHIP 1K	5% 1/10W	R096	1-216-065-91	RES,CHIP 4.7K	5% 1/10W
R044	1-216-657-11	METAL CHIP 1.8K	0.5% 1/10W	R097	1-216-073-00	RES,CHIP 10K	5% 1/10W
R045	1-216-049-91	RES,CHIP 1K	5% 1/10W	R098	1-216-073-00	RES,CHIP 10K	5% 1/10W
R046	1-216-073-00	RES,CHIP 10K	5% 1/10W [AEP]	R099	1-216-049-91	RES,CHIP 1K	5% 1/10W
R047	1-216-049-91	RES,CHIP 1K	5% 1/10W	R1001	1-216-049-91	RES,CHIP 1K	5% 1/10W
R048	1-216-049-91	RES,CHIP 1K	5% 1/10W	R1002	1-216-049-91	RES,CHIP 1K	5% 1/10W
				R1003	1-216-049-91	RES,CHIP 1K	5% 1/10W
				R1004	1-216-049-91	RES,CHIP 1K	5% 1/10W
				R1005	1-216-049-91	RES,CHIP 1K	5% 1/10W
				R1006	1-216-049-91	RES,CHIP 1K	5% 1/10W



REF.NO.	PART NO.	DESCRIPTION	REMARK	REF.NO.	PART NO.	DESCRIPTION	REMARK
R1007	1-216-049-91	RES,CHIP	1K 5% 1/10W	R1066	1-216-073-00	RES,CHIP	10K 5% 1/10W
R1008	1-216-667-11	METAL CHIP	4.7K 0.5% 1/10W	R1067	1-216-057-00	RES,CHIP	2.2K 5% 1/10W
R1009	1-216-049-91	RES,CHIP	1K 5% 1/10W	R1068	1-216-057-00	RES,CHIP	2.2K 5% 1/10W
R1010	1-216-049-91	RES,CHIP	1K 5% 1/10W				
R1011	1-216-049-91	RES,CHIP	1K 5% 1/10W	R1069	1-216-049-91	RES,CHIP	1K 5% 1/10W
R1012	1-216-057-00	RES,CHIP	2.2K 5% 1/10W	R1070	1-216-057-00	RES,CHIP	2.2K 5% 1/10W
R1013	1-216-057-00	RES,CHIP	2.2K 5% 1/10W	R1071	1-216-081-00	RES,CHIP	22K 5% 1/10W
R1014	1-216-049-91	RES,CHIP	1K 5% 1/10W	R5003	1-216-295-91	SHORT	0
R1015	1-216-049-91	RES,CHIP	1K 5% 1/10W	R5005	1-216-081-00	RES,CHIP	22K 5% 1/10W
R1016	1-216-049-91	RES,CHIP	1K 5% 1/10W	R5006	1-216-073-00	RES,CHIP	10K 5% 1/10W
R1017	1-216-049-91	RES,CHIP	1K 5% 1/10W	R5007	1-216-049-91	RES,CHIP	1K 5% 1/10W
R1018	1-216-049-91	RES,CHIP	1K 5% 1/10W	R5010	1-216-295-91	SHORT	0
R1019	1-216-049-91	RES,CHIP	1K 5% 1/10W	R5011	1-216-073-00	RES,CHIP	10K 5% 1/10W
R1020	1-216-065-91	RES,CHIP	4.7K 5% 1/10W	R5015	1-216-049-91	RES,CHIP	1K 5% 1/10W
R1021	1-216-065-91	RES,CHIP	4.7K 5% 1/10W	R5108	1-216-308-00	RES,CHIP	4.7 5% 1/10W
R1022	1-216-659-11	METAL CHIP	2.2K 0.5% 1/10W	R5109	1-216-308-00	RES,CHIP	4.7 5% 1/10W
R1023	1-216-659-11	METAL CHIP	2.2K 0.5% 1/10W	R5110	1-216-073-00	RES,CHIP	10K 5% 1/10W
R1024	1-216-681-11	METAL CHIP	18K 0.5% 1/10W	R5113	1-216-073-00	RES,CHIP	10K 5% 1/10W
R1025	1-216-025-91	RES,CHIP	100 5% 1/10W	R5115	1-215-859-00	METAL OXIDE	22 5% 1W F
R1026	1-216-109-00	RES,CHIP	330K 5% 1/10W	R5116	1-216-073-00	RES,CHIP	10K 5% 1/10W
R1027	1-216-659-11	METAL CHIP	2.2K 0.5% 1/10W	R5119	1-216-073-00	RES,CHIP	10K 5% 1/10W
R1028	1-216-647-11	METAL CHIP	680 0.5% 1/10W	R5122	1-215-859-00	METAL OXIDE	22 5% 1W F
R1029	1-216-025-91	RES,CHIP	100 5% 1/10W	R5205	1-216-073-00	RES,CHIP	10K 5% 1/10W
R1030	1-216-025-91	RES,CHIP	100 5% 1/10W	R5206	1-215-859-00	METAL OXIDE	22 5% 1W F
R1031	1-216-025-91	RES,CHIP	100 5% 1/10W	R5207	1-216-073-00	RES,CHIP	10K 5% 1/10W
R1032	1-216-025-91	RES,CHIP	100 5% 1/10W	R5208	1-216-069-00	RES,CHIP	6.8K 5% 1/10W
R1033	1-216-025-91	RES,CHIP	100 5% 1/10W	R5209	1-216-308-00	RES,CHIP	4.7 5% 1/10W
R1034	1-216-025-91	RES,CHIP	100 5% 1/10W	R5308	1-216-308-00	RES,CHIP	4.7 5% 1/10W
R1035	1-216-025-91	RES,CHIP	100 5% 1/10W	R5309	1-216-308-00	RES,CHIP	4.7 5% 1/10W
R1036	1-216-025-91	RES,CHIP	100 5% 1/10W	R5310	1-216-073-00	RES,CHIP	10K 5% 1/10W
R1037	1-216-025-91	RES,CHIP	100 5% 1/10W	R5313	1-216-073-00	RES,CHIP	10K 5% 1/10W
R1038	1-216-025-91	RES,CHIP	100 5% 1/10W	R5315	1-215-859-00	METAL OXIDE	22 5% 1W F
R1039	1-216-025-91	RES,CHIP	100 5% 1/10W	R5316	1-216-073-00	RES,CHIP	10K 5% 1/10W
R1040	1-216-025-91	RES,CHIP	100 5% 1/10W	R5319	1-216-073-00	RES,CHIP	10K 5% 1/10W
R1041	1-216-025-91	RES,CHIP	100 5% 1/10W	R5322	1-215-859-00	METAL OXIDE	22 5% 1W F
R1042	1-216-025-91	RES,CHIP	100 5% 1/10W	R5406	1-216-083-00	RES,CHIP	27K 5% 1/10W
R1043	1-216-025-91	RES,CHIP	100 5% 1/10W	R5407	1-216-085-00	RES,CHIP	33K 5% 1/10W
R1044	1-216-667-11	METAL CHIP	4.7K 0.5% 1/10W	R5408	1-216-308-00	RES,CHIP	4.7 5% 1/10W
R1045	1-216-065-91	RES,CHIP	4.7K 5% 1/10W	R5409	1-216-308-00	RES,CHIP	4.7 5% 1/10W
R1047	1-216-073-00	RES,CHIP	10K 5% 1/10W	R5410	1-216-081-00	RES,CHIP	22K 5% 1/10W
R1049	1-216-065-91	RES,CHIP	4.7K 5% 1/10W	R5413	1-216-097-91	RES,CHIP	100K 5% 1/10W
R1050	1-216-073-00	RES,CHIP	10K 5% 1/10W	R5415	1-215-887-00	METAL OXIDE	150 5% 2W F
R1051	1-216-097-91	RES,CHIP	100K 5% 1/10W	R5416	1-216-081-00	RES,CHIP	22K 5% 1/10W
R1052	1-216-073-00	RES,CHIP	10K 5% 1/10W	R5419	1-216-097-91	RES,CHIP	100K 5% 1/10W
R1053	1-216-049-91	RES,CHIP	1K 5% 1/10W	R5422	1-216-451-11	METAL OXIDE	120 5% 2W F
R1054	1-216-073-00	RES,CHIP	10K 5% 1/10W	R5502	1-216-081-00	RES,CHIP	22K 5% 1/10W
R1055	1-216-049-91	RES,CHIP	1K 5% 1/10W	R5503	1-216-081-00	RES,CHIP	22K 5% 1/10W
R1056	1-216-073-00	RES,CHIP	10K 5% 1/10W	R5504	1-216-089-91	RES,CHIP	47K 5% 1/10W
R1057	1-216-049-91	RES,CHIP	1K 5% 1/10W	R5505	1-216-089-91	RES,CHIP	47K 5% 1/10W
R1058	1-216-073-00	RES,CHIP	10K 5% 1/10W	R5506	1-216-069-00	RES,CHIP	6.8K 5% 1/10W
R1059	1-216-049-91	RES,CHIP	1K 5% 1/10W	R5507	1-249-382-11	CARBON	1.2 5% 1/4W F
R1061	1-216-073-00	RES,CHIP	10K 5% 1/10W	R5508	1-249-382-11	CARBON	1.2 5% 1/4W F
R1062	1-216-049-91	RES,CHIP	1K 5% 1/10W	R5509	1-249-382-11	CARBON	1.2 5% 1/4W F
R1063	1-216-065-91	RES,CHIP	4.7K 5% 1/10W	R5510	1-249-382-11	CARBON	1.2 5% 1/4W F
R1064	1-216-049-91	RES,CHIP	1K 5% 1/10W	R5602	1-216-081-00	RES,CHIP	22K 5% 1/10W
R1065	1-216-125-00	RES,CHIP	1.5M 5% 1/10W	R5603	1-216-077-91	RES,CHIP	15K 5% 1/10W
				R5604	1-216-081-00	RES,CHIP	22K 5% 1/10W

CPD-E500/E500E



REF.NO.	PART NO.	DESCRIPTION	REMARK
R5605	1-216-097-91	RES,CHIP 100K	5% 1/10W
R5607	1-215-862-11	METAL OXIDE 68	5% 1W F
R5610	1-216-308-00	RES,CHIP 4.7	5% 1/10W

<CRYSTAL>

X001 1-760-682-21 VIBRATOR, CRYSTAL (24.756MHz)

CPD-E500/E500E

9-978-667-01 1999LL05253-1